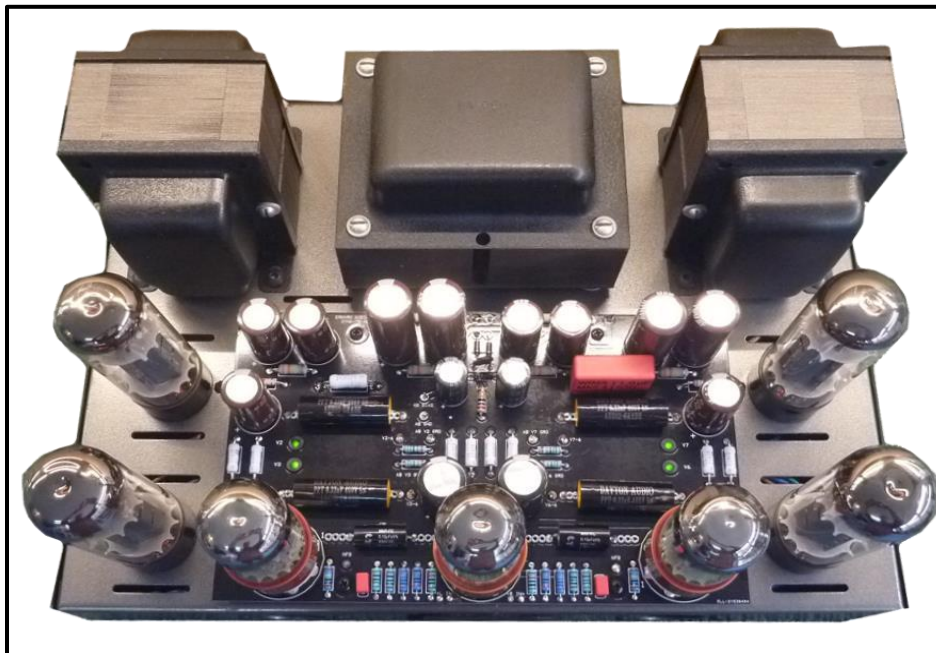




# **Dyna-70 Ultimate Upgrade For ST-70's**



## **Automatic Bias**

# **Assembly Manual, v1.1**

© 2023 All Rights Reserved  
Miller Audio LLC  
January 2025

# Dyna-70 Ultimate Upgrade

The "Ultimate" Dynaco ST-70 Upgrade Kit with Automatic Bias

## ASSEMBLY, INSTALLATION & OPERATION

### A. INTRODUCTION

Thank you for purchasing our Dyna-70 "Ultimate" ST-70 upgrade kit. The Dyna-70 Ultimate Upgrade will radically improve how your stock ST-70 sounds. In bringing this Made in U.S.A. classic tube amplifier up to modern design standards, it will reward you with an amazing listening experience! You won't believe how great your ST-70 will sound (even as good as a stock ST-70 sounds); you'll fall in love with your ST-70 all over again!

The Dyna-70 Ultimate Upgrade is based on the 6CA7 / EL34 power tube. If you have a good set of 6CA7 / EL34 tubes in your original ST-70, they will work fine with the Dyna-70 Ultimate Upgrade. We recommend that you stay within the 6CA7 / EL34 tube group. The B+, Cathode and Plate voltage levels in our driver circuit are optimized to suit 6CA7 / EL34 tubes. We DO NOT endorse use of other tube types (6L6, KT66, KT88, etc.) with the Dyna-70 Ultimate Upgrade. Use of any other tubes will void the warranty of the upgrade kit, including the Auto Bias Module.

Successful operation of the Dyna-70 Ultimate Upgrade assumes that all your transformers are in good working condition, to include the C-354 power supply choke. These chokes are commonly found having experienced thermal stress over the years, where the wax used for sealing the coils is melted and found on the bottom cover. Should you need to replace the C-354 choke, we recommend use of the Dynakit Parts C-354, which feature bell end covers that enclose the coil, giving a modest reduction in RF-noise and ensures no more leakage. The Triode Electronics C-354 is another option.

Our kit was developed and tested using the third generation of the Dynaco PA-060 power transformer with a lamination stack of approximately 2 inches in height. DO NOT use a first or second-generation PA-060 transformer that has a stack height of 1.0 or 1-1/2 inches. These early versions of the PA-060 will get too hot due to the higher current load of the 6SN7 filaments. If your ST-70 has a first or second-generation PA-060, you MUST replace with the latest generation PA-060 transformer from Dynakit Parts or Triode Electronics.

NOTE: With the Dyna-70 Ultimate Upgrade kit we integrated a modern, solid-state rectifier on the Dyna-70 CCA, eliminating the rectifier tube. The 5V AC filament winding for the rectifier tube is not used with our upgrade, reducing power demand on the PA-060 power transformer; it will operate cooler than earlier generations of PA-060 Power Transformers.

Finally, we use quality, name brand components from manufacturers such as Nichicon, United ChemCon, Panasonic, Wima, Solen and Audyn. We source most of our parts from Mouser, Digi-Key, CE Distribution, Dynakit Parts and other reputable U.S. suppliers; you can trust all parts are genuine and not counterfeit components.

Purchase, assembly, and use of this audio upgrade assumes the builder/integrator of the Dyna-70 Ultimate Upgrade has experience and knowledge of working in and around tube amplifiers. This kit rates on a "medium" scale of assembly complexity; it should be stressed **this is not a beginner's kit.**

- ***Be EXTREMELY careful when working with a live amplifier, the high voltages are LETHAL!***
- ***You are working with 720V AC & 400V DC voltage – exercise EXTREME caution, use only one hand!***
- ***The exposed metal on top of all the electrolytic capacitors is hot with high voltage, DO NOT TOUCH!***
- ***Always use the Tube Cage!***

## **B. ABOUT THIS MANUAL**

This manual provides information needed to assemble, test, and operate the Miller Audio LLC Dyna-70 Ultimate Upgrade kit, transforming a stock Dynaco ST-70 into a superior sounding push-pull amplifier based on the EL34 tube. We recommend that you also have available the original Dynaco ST-70 Assembly Manual for reference.

**Who Should Attempt this Project?** You can build this kit if you can:

- Solder (using normal rosin core solder and a temperature-controlled soldering iron).
- Use simple hand tools like screwdrivers, wire cutters, and pliers.
- Read and follow directions.
- Use a methodical approach to assembly, checking all part values for correct value and polarity.
- Remember to check everything – two or three times! Ensure you are using the correct value and check it again.
- Keep a checklist of each item installed.
- Inspect your work.
- Have a friend, who builds electronics also check your work (multiple heads and eyes help to minimize errors).

### **Tools Needed:**

- Phillips screwdriver (#1 and #2)
- Slotted screwdriver (#1 & #2)
- Pliers, wrenches, sockets, or nut drivers suitable for #4 (4-40), #6 (6-32) and #8 (8-32) hardware
- Needle nose pliers
- Pencil type soldering iron of 40 to 50 Watts (we recommend commercial soldering systems such as Oki or Metcal)
- Wire cutters and Wire strippers (24 ga. to 18 ga. solid and stranded copper wire)
- You MUST use a digital multi-meter to measure voltages and confirm resistor values

### **The amplifier upgrade consists of the following steps:**

- Preparation of your ST-70 for the Dyna-70 Ultimate Upgrade installation
- Assembly of the Dyna-70 driver printed circuit board.
- Installing the Dyna-70 Ultimate Upgrade CCA into the ST-70 amplifier.
- Optional: Installation of the Auto Bias Module
- Final test of installation, setting bias (manual bias version), checking B+ voltage.

### **Important Safety Notes**

*By purchasing, using, or assembling this kit, you have agreed to hold Miller Audio LLC harmless for any injuries you may receive in its assembly and/or use. To prevent injuries:*

- Wear safety glasses when soldering or clipping wires to prevent eye injuries.
- Always unplug the power before working on the amplifier. Large capacitors hold energy for a long time.
- Before you put your hands into the amplifier:
  - o Cut all power to amplifier by pulling the AC plug from the wall - do not depend on the power switch!
  - o Wait at least 5 minutes for the capacitors to discharge!
- Remove jewelry, watches and rings from your hands and wrists, or anything that might dangle into the amplifier.
- If working on the equipment with the power on, keep one hand in your pocket, especially if you are near the power supply or power supply wires. This can prevent serious shocks.
- Build with a friend nearby- if you ignored all the previous advice, they could dial 911 or get you to a hospital.

### **About Design and Components Used**

Miller Audio LLC reserves the right to make changes in design, components, component substitutions or assembly processes, procedures, and instructions at any time without notification. Watch for notices and updates on our website.

### **Guarantee**

Except for fuses and vacuum tubes, Miller Audio LLC will replace any parts of a correctly assembled product that fails within 90 days of purchase. It is the responsibility of the kit builder to install the replacement part(s). This guarantee applies to the original kit purchaser only. It does not apply to units that have been physically or electrically abused,

modified without authorization, or assembled with any solder other than 60/40 or 63/37 Rosin Core solder. Miller Audio LLC's liability shall in no event exceed the cost paid to Miller Audio LLC for the Dyna-70 Ultimate Upgrade kit.

### Kit Building Hints

Please take a minute and read the advice of this section. We've condensed into bullets if in a hurry:

- Stop any time you're feeling tired, confused, or anxious. Taking breaks will keep the build enjoyable and enhance your chances of first-time success.
- A digital ohmmeter is an easy way to check that you've selected the right resistor. It's a great cross-check on the resistor color code. Measure twice - solder once!
- A lead-bending jig can make for quicker, neater assembly
- Is something in this manual confusing, or did you find an error? Send your questions & comments to [info@milleraudiollc.com](mailto:info@milleraudiollc.com). You will help yourself and everyone who builds a Dyna-70 Ultimate Upgrade kit.

## C. RECOMMENDED TOOLS & MATERIALS

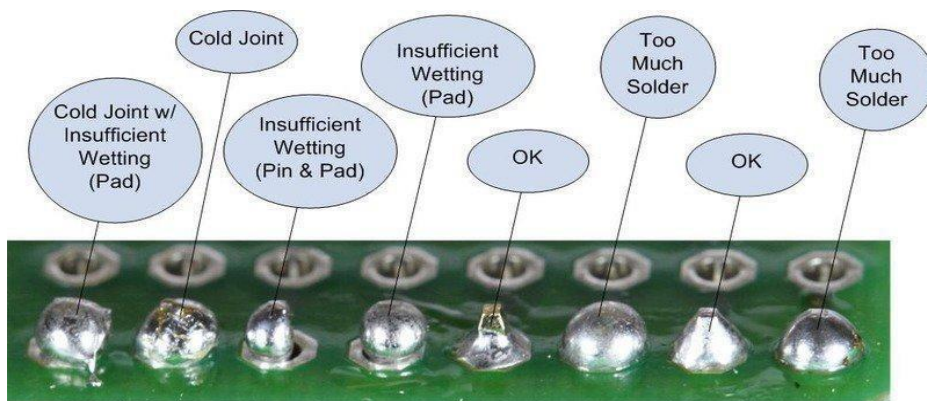
### Solder, Soldering Irons and Soldering Technique

A major issue encountered when customers build their own kits is poor soldering. In fact, most repairs in kit-built systems are due to poor soldering. We cannot stress enough: good soldering skills are a MUST! We are assembling a system that requires high voltage and current for stable operation and best sound quality; it is vital that each solder joint is as near perfect as possible. Avoid cold solder joints, improperly "wetted" joints that don't "fuse" together well, and properly strip and tin each wire before soldering to its assigned terminal.

We recommend use of temperature-controlled soldering irons from brands such as Oki, Metcal, Weller or Hakko. You should have a collection of tips ranging from small to medium size. DO NOT waste time or money using inexpensive, general-purpose, single-temperature soldering irons- you will damage the CCA and components.

Only use lead-based solder with a rosin core made for soldering electronic components. Ensure rosin is NOT an acid-type used for joining sheet-metal or stained glass came. DO NOT waste your time with unleaded solder. Use Kester 60/40 lead solder in several sizes (0.020" - 0.030" diameter), however 63/37 is an acceptable alternative and can be mixed in use with 60/40 solder.

If you have not soldered in a while, we recommend that you buy some inexpensive general purpose experimental PCB (aka "Perf Board") from eBay, Parts Express, Jameco Electronics, etc. along with a bag full of resistors, and practice your soldering skills before you start building this kit. If you have never soldered before, **PLEASE STOP NOW, this is not a beginner's kit!**



#### **D. ST-70 UPGRADE PREPARATION**

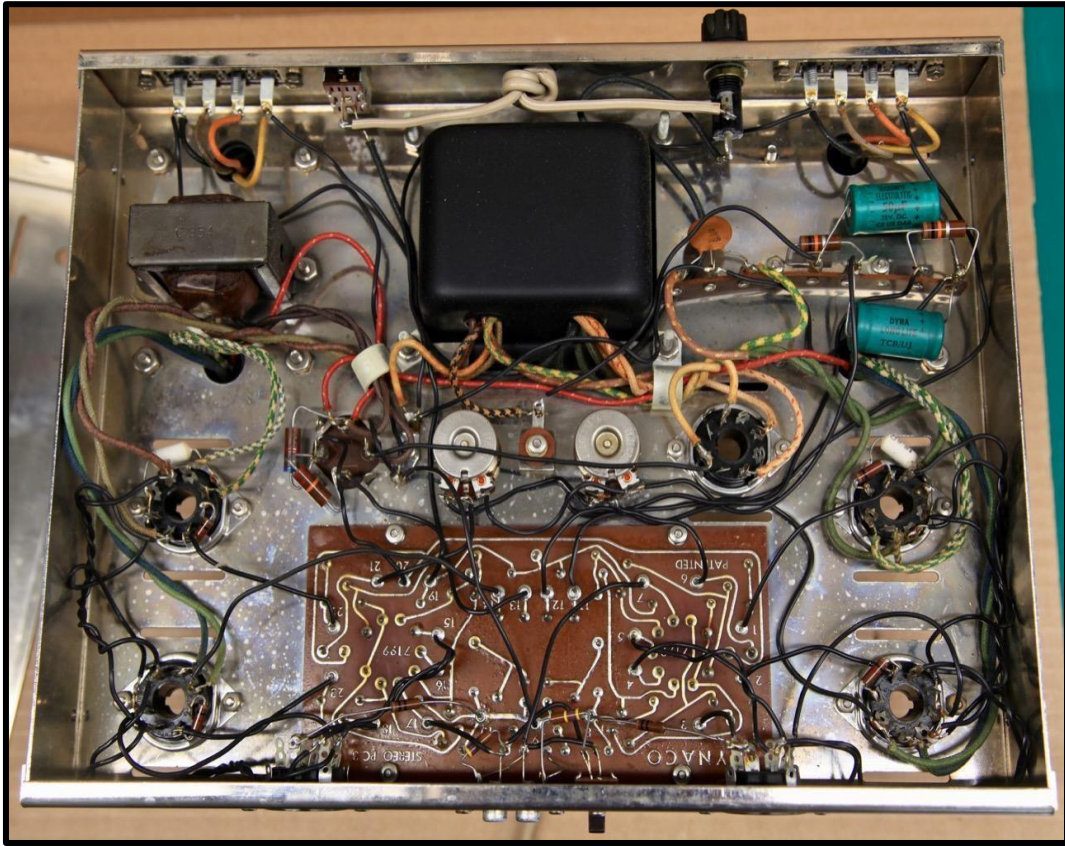
You will remove most internal components of an original ST-70. This is an opportune time to clean/polish the Nickel-plated steel chassis, as well as clean and repaint of your transformers. If your chassis is pitted, rusty or has discolorations to the Nickel plating, this is a good time to consider replacing the chassis since you will likely remove all transformers and most all other items that attach to the chassis “while you are in there” (WYAIT- pronounced “Wyatt”). This is entirely up to you, but if you have any doubts, we recommend you replace the chassis. Just look at new ST-70 builds, or some of our pics in this manual or on our website. One doesn’t want to have a premier sounding amplifier, that doesn’t look premier as well.



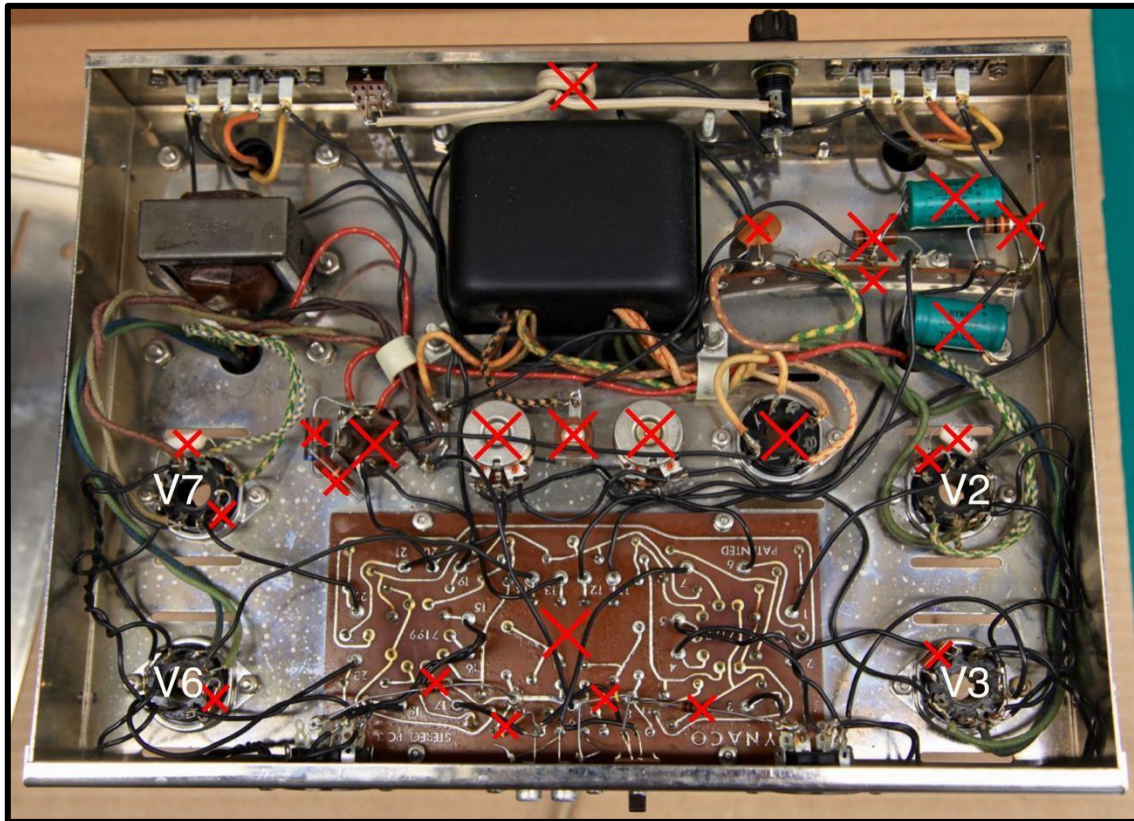
**An Original ST-70 with a first-generation PA-060 Power Transformer**

Remove the Tube Cage, tubes, and the bottom chassis cover. Place your ST-70 upside down and proceed to next page.





Typical Internal View of an Original Dynaco ST-70



Remove All Parts Marked with a **Red X**

Use the above photo as a guide to remove parts not required for the Dyna-70 Ultimate Upgrade

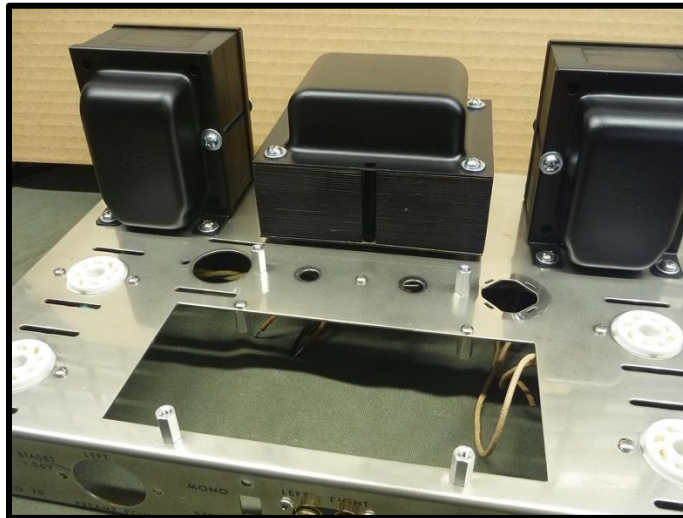
1. Remove the two electrolytic capacitors that solder to the terminal strip and are colored Blue (branded caps were Red, Yellow, Green, or even an aluminum can with clear shrink and printed markings) in the above photo. These

are caps used for the negative voltage bias power supply, and no longer needed in the Dyna-70 Ultimate Upgrade.

2. Remove the two resistors soldered to the same terminal strip.
3. Remove the terminal strip and disconnect all the wires going to it. Do not cut the green/yellow and brown/yellow wires short. Just disconnect them from the terminal strip and leave them. You will replace the old terminal strip and the ceramic disc capacitor with the new ones that we supply with the kit.  
**NOTE: you will need to remove the left output transformer (OPT) to remove the screws for the terminal strip!** If you do not want to have to remove the left OPT, you can leave the original terminal strip in place but remove all the wires, resistors, and the ceramic capacitor.
4. Remove the two bias adjust potentiometers (just below the PA-060 power transformer) and all the wires going to the potentiometers.
5. Remove the selenium rectifier used for the negative voltage bias power supply, and all wires going to it.
6. Remove the 5AR4/GZ34 rectifier tube socket located to the right of the bias potentiometers in the above photo. Disconnect all wires that attach to the rectifier socket. DO NOT cut them short or cut them off. Unsolder all wires from the rectifier terminals on the rectifier socket.
7. To remove the multi-section Capacitor can, first remove all resistors soldered to terminals. Then remove all the wires soldered to the cap can. Disconnect the two red and two brown wires- DO NOT cut them short or cut them off!
8. Remove the 2 white 15.6-ohm resistors, located between pins 1 & 8 and the tube socket ground terminal from power tube sockets V2 & V7.
9. Remove the resistors from each power tube socket (V2, V3, V6 & V7) between pins 5 & 6.
10. Remove all the wires going to the original ST-70 PC-3 driver CCA, as well as the RCA signal input sockets, the MONO/STEREO switch, and the two front octal sockets.  
(NOTE: The MONO/STEREO switch will no longer function. We recommend you leave in-place for appearance purposes).
11. Disconnect the green/white and the blue/white output transformer (OPT) wires from the power tube sockets V2 & V7 that are connected to pins 3 & 4. These will need to be rerouted to the sockets of V3 and V6 and possibly spliced and lengthened.
12. Disconnect the green and blue OPT wires from the power tube sockets V3 & V6 that are connected to pins 3 & 4. These will need to be rerouted to the sockets of V2 and V7.
13. Leave the two green filament wires going to power tube socket V2 on pins 2 & 7.
14. Leave the two brown filament wires going to power tube socket V7 on pins 2 & 7.
15. Leave the two filament interconnecting wires between V2 and V3 on pins 2 & 7, and V6 & V7 on pins 2 & 7.
16. Remove the power cord and discard. After 40+ years the insulation has dried out and prone to cracking. The Dyna-70 Ultimate Upgrade kit includes a new power cord.
17. Leave the speaker output wires connected to the speaker terminals including the wire connected from the ground speaker terminal to the chassis star ground UNLESS you intend to replace the old speaker terminals with new ones, are removing to paint the transformers, or replacing the chassis.
18. Leave the power switch in but disconnect both wires going to it.
19. Leave the fuse holder in but disconnect the wires going to both tabs.
20. Now install the eight aluminum spacers as shown below. Six have two threaded holes each and two have one threaded hole and one threaded stud.  
  
a- the spacers with the one threaded stud go on the inside of the two front holes of the chassis with the threaded stud through each hole, see photo next page.

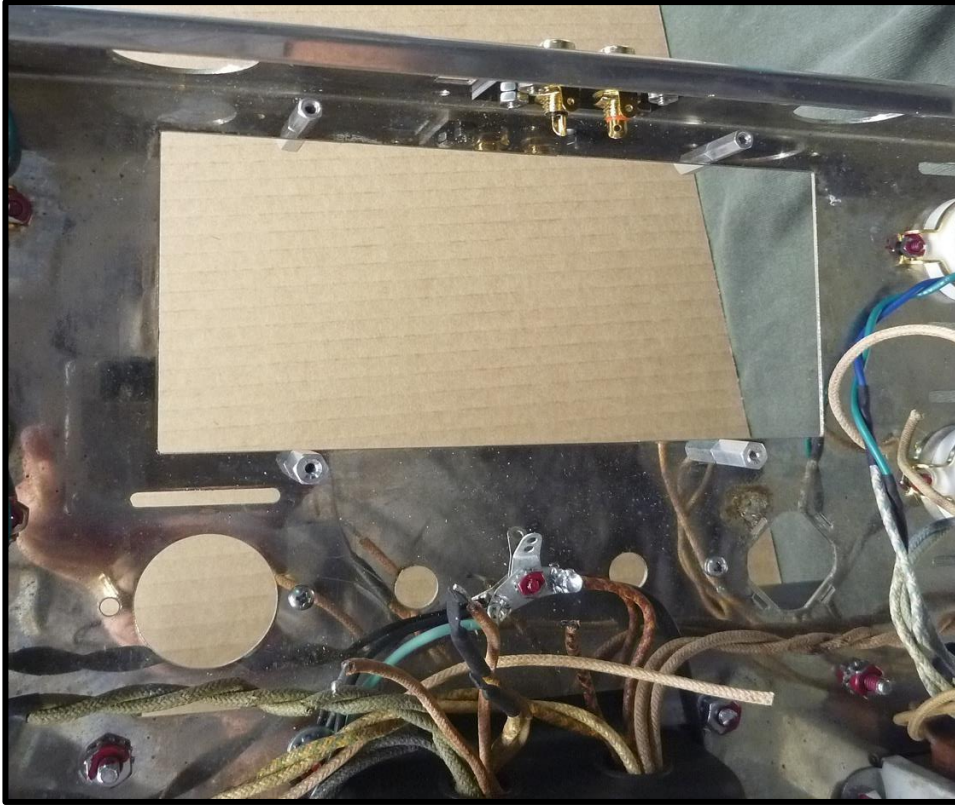


b- Two of 'two holed' spacers is screwed onto the threaded studs in the front holes and two in the rear holes using 4-40 screws, on the top of the chassis, see photo.

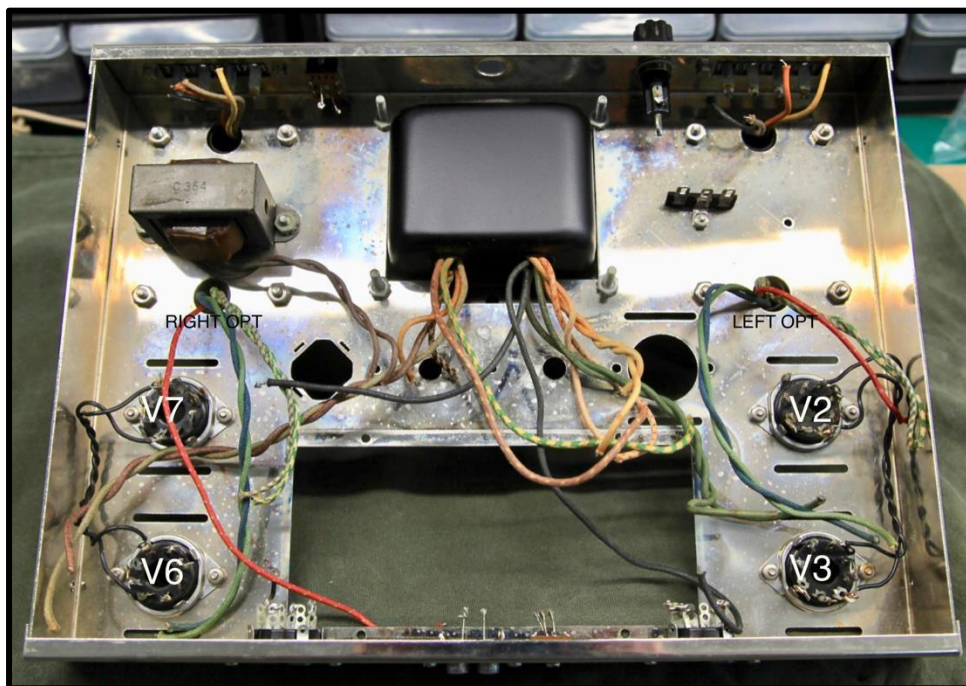


c- the remaining 'two holed' spacers get screwed into the top two holes of the cutout to the inside of the chassis, you should end up with four spacers on the inside and four spacers on the top of the chassis, see photo.





We recommend that you clean all terminals on the remaining tube sockets, power switch, fuse holder and terminal strip after you have removed all wires and resistors. This can be a tedious job but will make soldering new wires and components easier and neater. We recommend use of both a solder sucker and solder wick / braid to facilitate clean-up of all terminals.



**This is how your ST-70 appears after component deletion**

NOTE: We have left the heater filament interconnect wires between V2 & V3, pins 2 & 7, as well as between V6 & V7, pins 2 & 7 (colored black in photo above). Those are the ONLY wires left from the original hookup wiring. Note that we disconnected the output Transformer wires as we are replacing the old speaker terminals with new ones. We also mounted the new terminal strip for the center tap grounds for the filament heaters. At this point we removed the output transformers on our demonstration ST-70 and repainted the bell covers and the lamination stack and replaced the fasteners and red fiber washer.

#### **E. DYNA-70 ULTIMATE UPGRADE CIRCUIT CARD ASSEMBLY (CCA)**

Start with all low-profile components and work your way up in size. This makes soldering easier. Note the orientation of the electrolytic capacitors; ensure you get the polarities correct. Also note the polarities of the bias supply diode as well as the two rectifier diodes and ensure their polarities are correct. For the PCB mounted electrolytic caps, note that ALL of them have the negative lead facing the rear of the PCB (towards the transformers)- a simple and easy way to check that they are in correct orientation/polarization.

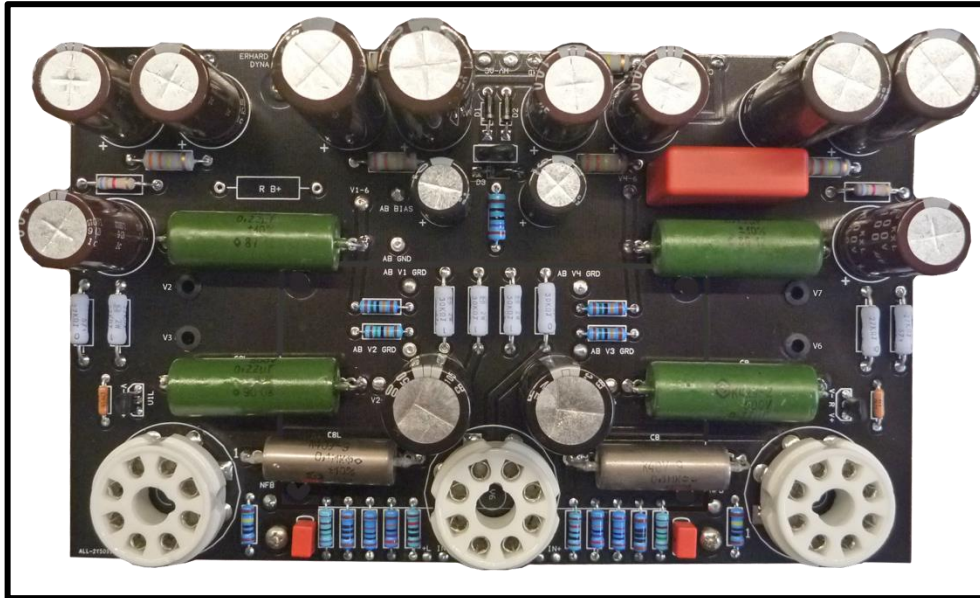
NOTE on R B+: The kit includes three different resistor values for R B+; these are packaged together for easy ID. The resistor values are 2.2K, 3.3K and 4.3K, and all are 3W. You will need to choose the correct R B+ resistor value, depending on your household main AC supply voltage, which may vary from approximately 115V to 125V, depending on your power provider. If your house AC line voltage is approximately **115-118VAC, use the 2.2K resistor**; around **118-122VAC use the 3.3K resistor**, and for **122-125VAC use the 4.3K resistor**. The ideal B+ voltage is around 370-380 VDC. The above indicated voltages are an approximation, you may need to fine tune the value of R B+. You can leave R B+ out for now, or if you know what your household AC supply level is, install the appropriate value for R B+.

It is important to note that U1/U1L (LM-334) have been replaced with SMT-334 and relocated to the bottom side of the PCB to shield them from tube heating. When installing the SMT-334 you must maintain the correct polarity. Here is an easy way to determine orientation: When installing the SMT-334's from the backside of the PCB you will orient the flat side of each SMT-334 (the side with the square black chip) to face to the right side of the PCB (i.e., towards the 3 o'clock position) when viewing the bottom of the PCB oriented with the three 6SN7 tube sockets toward you. We suggest you carefully review ECN002 which has been included in this manual.

Note: If you chose to use PIO coupling capacitors, leave a small space between the body of the capacitor and the CCA. These capacitors have a metal body, and we do not want the body too short to the CCA. We recommend that you use heat shrink to insulate the PIO capacitors. The heat shrink and PIO caps are not included in the kit!



Other than the spacing for PIO coupling capacitors, assembly of the CCA is straight forward and simple. Use a capacitance meter and a digital VOM multimeter to ensure that all component values are verified before installing in the CCA. Again, we stress the importance of GOOD SOLDERING!



**A Dyna-70 Ultimate Upgrade w/Auto Bias CCA w/ optional PIO coupling capacitors**

### **Wiring & Installing the Dyna-70 Ultimate Upgrade Circuit Card Assembly (CCA)**

To make it easier to wire up the CCA, we recommend that all the power supply wires be pre-soldered to the CCA as most of these wires will need to be spliced as the original wires from the PA-060 power transformer and the power supply choke are too short to reach the new CCA. We have included 18-gauge wires and heat shrink to make the job of splicing the wires easy for you. You will find the following 18-gauge colored wires in the kit: brown, green, yellow, orange, red, blue, black & purple.

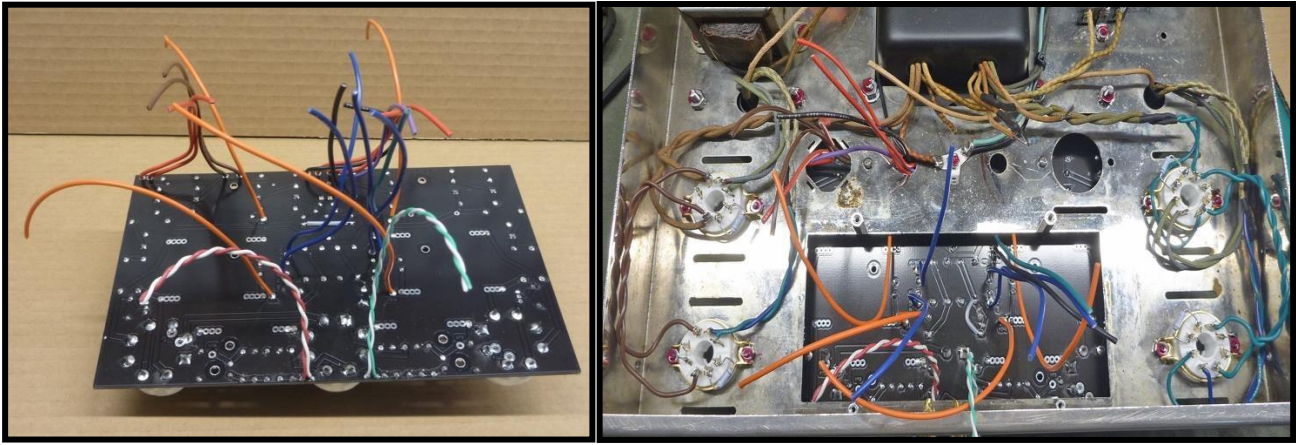
You will see a row of solder pads along the top edge, middle and bottom of the CCA for the power supply and other connections marked OPT B+, CHOKE, GND, HV AC, BIAS, AB module connections (applies only to an AB version Dyna-70 CCA) and inputs. Cut each of the following wires to 5"/127 mm lengths, strip both ends about 0.2"/5 mm and tin with solder: four red, two brown, two black, one purple, four blue and one green wire. Also cut 4 orange wires at 6"/155 mm, strip and tin them with solder. **Solder these wires on the bottom side of the CCA!**

21. Solder a red wire each into the following pads: OPT B+ x2 and HV AC x2.
22. Solder a brown wire each into the following pads: CHOKE x2.
23. Solder one purple wire into the BIAS pad.
24. Solder a black wire each into the GND AND the AB GND pad.
25. Solder a blue wire each into the following pads: AB V2 GRD, AB V3 GRD, AB V6 GRD & AB V7 GRD
26. Solder a green wire into the AB-BIAS pad
27. Solder an orange wire each into the following pads: V2-6, V3-6, V6-6, and V7-6.

There are also four smaller -pads at the bottom of the CCA, one pair marked +L IN- and one pair marked -R IN+. These are the left and right inputs for the driver circuit. In the kit you will find two short lengths of pre-twisted 24-gauge hookup wires, one green/white and one red/white. Cut each pair of pre-twisted wires to 2"/50 mm length, strip one end and pre-tin with solder.

28. a- Use the green/white pair for the left channel. Solder the green wire in the +L pad and the white in the IN- pad of the +L IN- pair of pads.
- b- Use the red/white pair for the right channel. Solder the red wire in the IN+ pad and the white in the -R pad of the -R IN+ pair of pads.





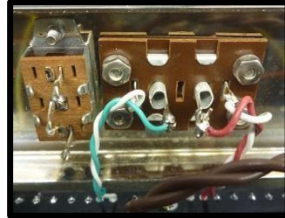
You can now install the CCA on the top of the chassis onto the four aluminum spacers. Pass the wires through the holes in the chassis which were left when the rectifier and cap can were removed. Use the closest available hole for each wire. Fasten the CCA into place using the included 4-40 pan head screws. All wires attached to the CCA now need to be connected.

29. Start with the two Red OPT B+ CCA wires. These need to be spliced to the red OPT primary center tap wire. It does not matter which of the two red CCA wires goes to which OPT red wire. Start off with a clean end of each OPT red wire, trim off any old, exposed wire, and strip a new length of 0.2"/5mm. Now these wires may have oxidized over the years, they will be quite dark and tarnished. Use fine sandpaper and clean the tarnish off the end leaving a nice, clean surface. Pre-tin each stripped lead with solder. Next cut two 3/4"/19mm pieces of shrink tubing and slide one each over the read OPT B+ wires from the CCA. Neatly route the OPT red wires to the two red OPT B+ wires and trim each red wire to the required length. Solder each joint neatly, making sure you do not end up with a dry joint. Slip the shrink tubing over the joint and shrink it tight by applying heat. Use the same method of trimming and cleaning the ends of all the original wires and pre-tinning them with solder, and then cut a piece of 3/4"/19mm piece of shrink tubing for each additional wire joint.
30. Next do the same with the two brown CHOKE CCA wires. Neatly route the two brown wires from the power supply choke to the brown CCA wires and connect each as described above. You can twist these to make it neater.
31. Again, do the same for the two red HV AC wires, and with these you MUST TWIST them. Also twist the two red wires from the power transformer and connect each as described above. Because these are AC, it does not matter which red CCA wire goes to which red power transformer wire.
32. Connect the black GND CCA wire to the chassis star ground.
33. Connect the purple BIAS CCA wire to the or Red/Black bias wire from the PA-060
34. There is a red/yellow wire from the PA060 transformer, the center tap of the secondary winding, and this is soldered to the chassis star ground.
35. There two 0.022uF film capacitors with the kit (sometimes green, brown, or orange). These are soldered to the terminal strip; solder each capacitor as shown in the following photo.
36. There are a brown/yellow and a green/yellow wire coming from the power transformer. These are the center taps for each of the two 6.3VAC filament windings.
  - a- connect the brown/yellow to one leg of one of the 0.022uF capacitor.
  - b- connect the green/yellow to one leg of one of the other 0.022uF capacitor.
 Note, that the center terminal is also the mounting terminal, so it will be grounded to the chassis. Refer to the photo below for details.





37. Now connect those short lengths of the 24-gauge pre-twisted wires. Trim to length.
- a- connect the red/white to the right RCA jack, the red to the RCA center tab, and the white to the RCA ground terminal.
  - b- connect the green/white to the left RCA jack, the green to the RCA center tab, and the white to the RCA ground terminal.



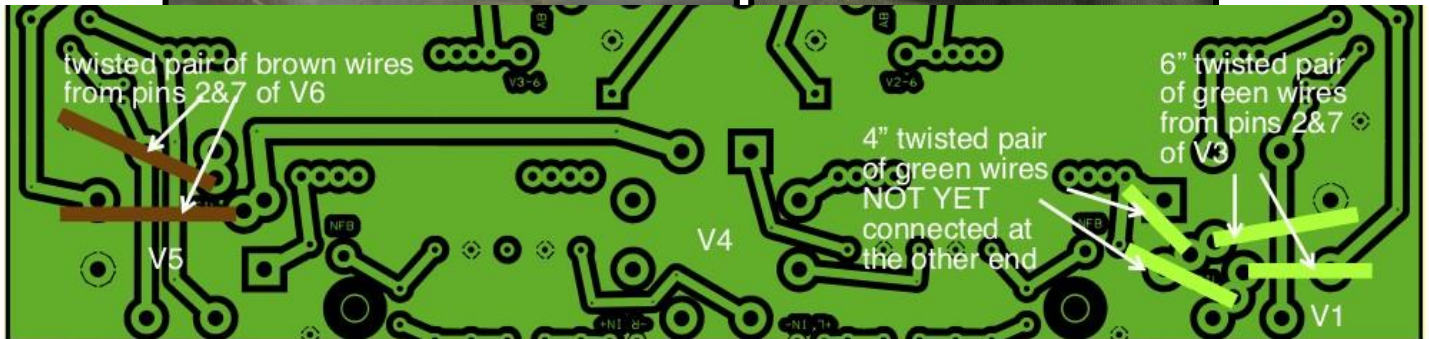
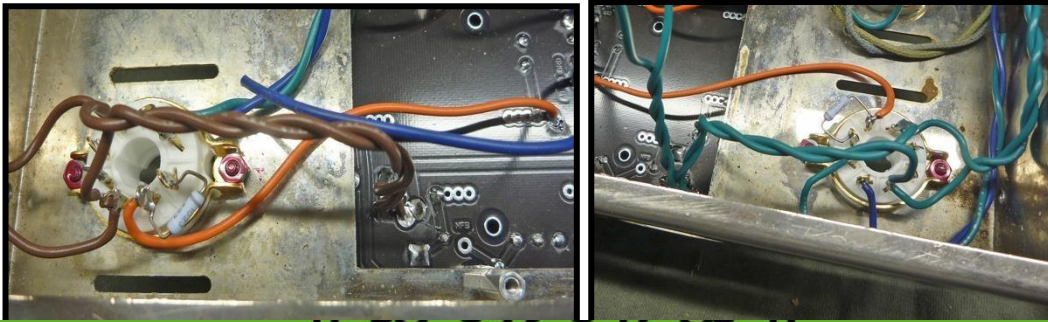
38. With the elimination of the tube rectifier, there are two white wires from the PA-060 power transformer, which are not used. Trim the ends and slip a length of heat shrink tubing about halfway over the lead ends. Heat the heat shrink; once it has shrunk, pinch the top half of the tube to close it off. See photo below. These two white wires can be folded together tied off neatly.



Now we start with the remaining wiring to the CCA and tube sockets as well as installing some resistors. As previously mentioned, we need to reroute the green/white, the blue/white, blue and green wires from the OPT primaries to different tube sockets. The reason is that we designed the layout of our CCA to look neat and orderly, which resulted in having to reroute those wires. As luck would have it, you only need to splice one set each of green/white and blue/white wires, namely the ones that connect to socket V3. The other green/white and blue/white wires are just long enough to reach socket V6 whereas the blue and the green wires that were going to sockets V2 and V7 need to be trimmed even shorter.



39. There are four 1K 1W resistors in the kit.
  - a- Connect one 1K resistor on each tube socket, V2, V3, V6 & V7, between pins 5 & 6. See photo above.
40. Now start with the left OPT transformer wiring. Cut one piece each of green and blue wire 4"/100mm long. Strip one end and pre-tin with solder.
  - a- Splice the green wire to the green/white left OPT wire, and the blue wire to the blue/white left OPT wire.
  - b- Twist the spliced wires to make them neater, and route them neatly to socket V3 and trim as required.
  - c- Connect the green (green/white) wire to pin 4 of V3 and connect the blue (blue/white) wire to pin 3 of V3.
41. Take the left OPT blue and green wires. Twist them for neatness and route them neatly to socket V2. Trim them shorter as required.
  - a- Connect the green wire to pin 4 of V2 and the blue wire to pin 3 of V2
42. Twist and then route the right OPT green/white and blue/white wires to V6. They should be just long enough without having to splice them. If they are not, then you'll need to splice them with a green and blue wire respectively as described in step 40. Connect the green (green/white) wire to pin 4 of V6 and the blue (blue/white) wire to pin 3 of V6
43. Twist and then route the right OPT green and blue wires to V7, trimming them shorter as required.
  - a- Connect the green wire to pin 4 of V7 and the blue wire to pin 3 of V7.
44. Cut two yellow wires of 12"/300mm, strip one end and pre-tin with solder. These are the negative feedback (NFB) wires. If you have retained the original Dynaco speaker terminals, connect this yellow wire to the 16 OHM speaker terminal. If you have bought a 3-way speaker post upgrade, splice the yellow wire DIRECTLY to the OPT yellow wire.
  - a- Route the yellow wire neatly, trim as required, and connect to the left channel NFB pad on the CCA.
  - b- Repeat for the right channel NFB connection.
45. Connect one end of the orange wires soldered in step 27 to pin 6 of each tube socket, V2, V3, V6 & V7.
  - a- Now connect the orange wire from V2-6 pad on the CCA to pin 6 on V2.
  - b- Now connect the orange wire from V3-6 pad on the CCA to pin 6 on V3.
  - c- Now connect the orange wire from V6-6 pad on the CCA to pin 6 on V6.
  - d- Now connect the orange wire from V7-6 pad on the CCA to pin 6 on V7.
46. We now need to feed the 6.3VAC filament supply to the three 6SN7 tubes on the driver CCA.
  - a- Cut two brown wires of 6"/150mm length. Strip BOTH ends and pre-tin with solder.
  - b- Now twist the two wires together so that you end up with a pair of twisted brown wires.
  - c- Solder one end of the twisted brown pair to pins 2 & 7 on V6, and then solder the other ends to the FIL pads of V5 on the CCA. See illustration below.
  - d- Cut two pieces of green wires of 6"/150mm length and two green wires of 4"/100m length. Strip BOTH ends and pre-tin with solder.
  - e- Now twist each 6" and 4" pair of wires together.
  - f- Solder one end of the 6" twisted green wires to pins 2 & 7 on V3, and then solder the other ends to the inner pads of the FIL pads of V1 on the CCA.
  - g- Solder one end of the 4" twisted green wires to outer pair of the FIL pads of V1 on the CCA, leave the other end free for now; see photos below.



47. Speaker terminal connections (NOTE: If you did not remove the old Dynaco speaker terminals or any transformer wiring to them, skip this step).
48. If you opted for the optional new speaker terminals, connect them as follows:
  - a- Connect the orange OPT wire to the 8 OHM post, the brown OPT wire to the 4 OHM post and the black OPT wire to the C/Ground post AND to chassis ground! This is an often a missed step in building ST-70's!
  - b- Cut two pieces of black wires of 10"/250mm length and strip one end.
  - c- Now twist the stripped end of each black wire to the stripped end of the black OPT wire together, solder and then connect them to the GROUND speaker post
  - d- Route the other end of the 10" black wire neatly to the chassis star ground tabs, trim as required and solder to the tabs

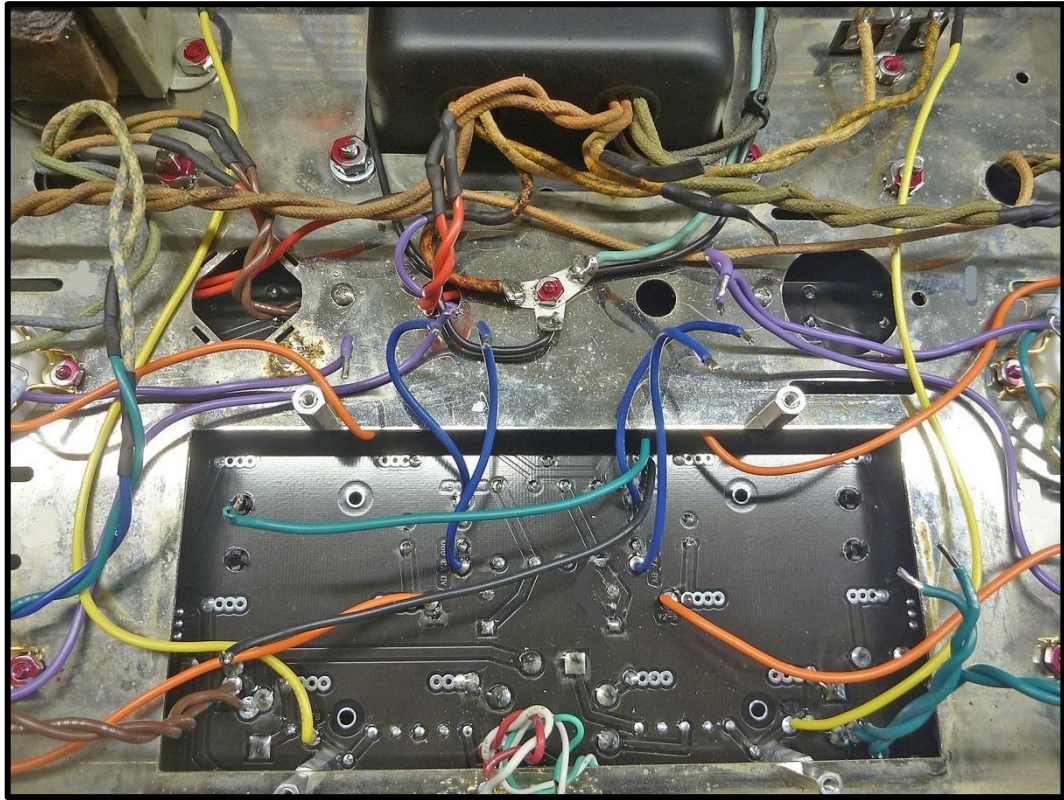
#### **Installing and Wiring the Optional Auto Bias Module**

Please DO NOT adjust the small blue trimmer on the AB module CCA, as this will change the bias setting. If you choose to change the pre-set bias level, we cannot take ANY responsibility of the correct continued operation of your AB-Q-70/120 module and you risk damaging the output tubes! Please Do Not adjust the Auto Bias Module it is Preset!

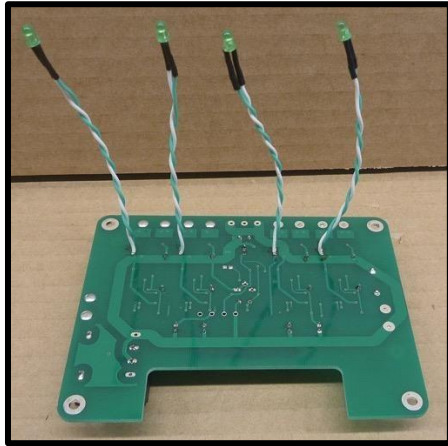
There should be a total of six wires left on the Dyna-70 driver CCA which have one end yet to be connected. These wires were installed in steps 21 through 27 and should consist of one black, four blue and one green wire. The AB module CCA will get installed onto the four aluminum spacers on the inside of the ST-70 chassis. This can be a bit fiddly, so take your time. All the connections to the AB module are around the PCB edges and marked.

49. Direct the four blue wires towards the power transformer and the black & green wires towards V6 & V7, reference photo below.





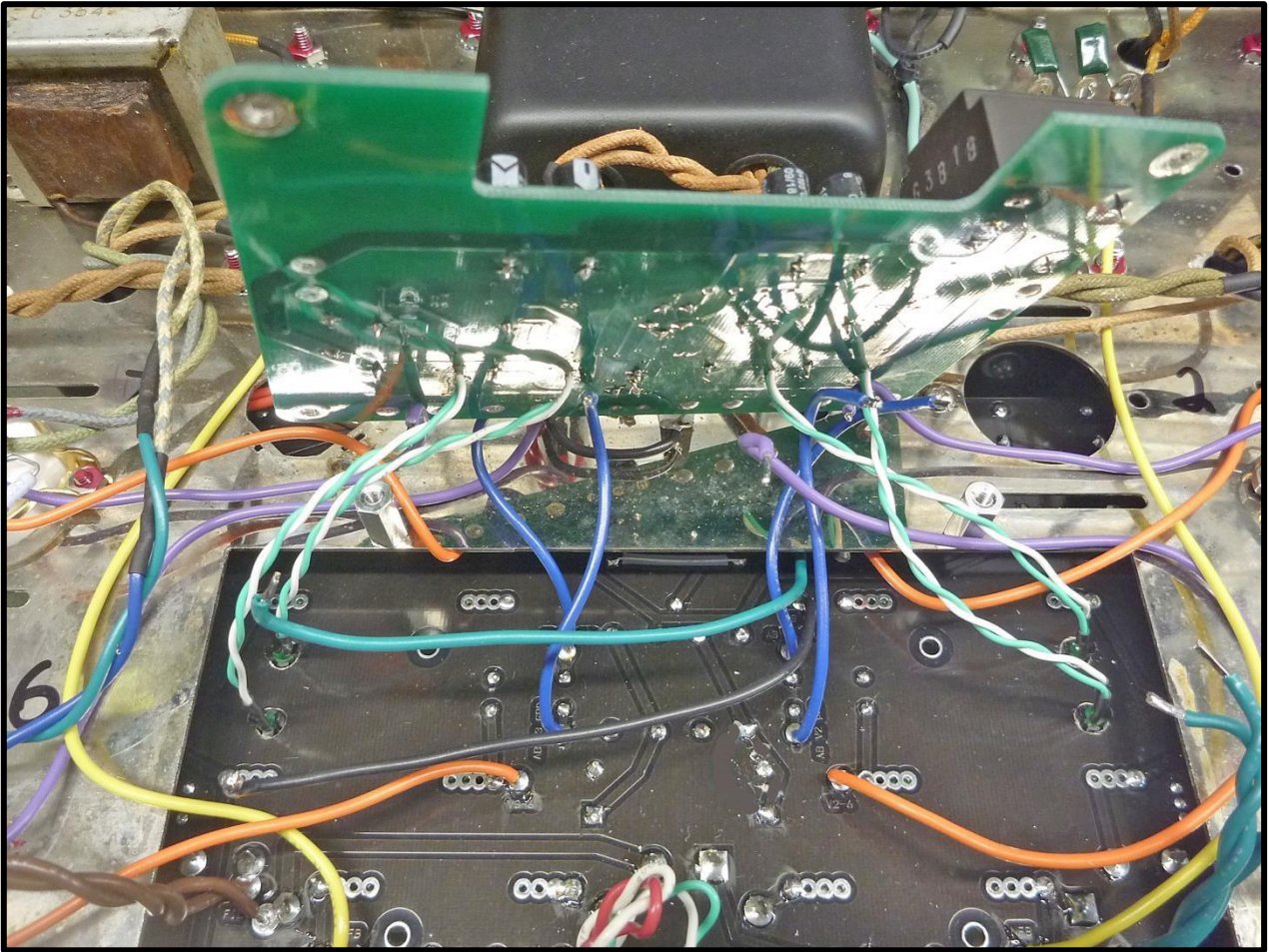
Note that the AB-Q-ST70/120 Auto Bias (AB) module used for our Dyna-70AB kit has been modified with four remote 3mm green LEDs marked V2, V3, V6 & V7. The standard AB-Q-ST70/120 module has the LED's mounted as surface mount components. Since the AB-Q-ST70/120 module is mounted inside the chassis, these surface mounted LEDs are not visible to the user.



These LED's show the bias status of each output tube and it is therefore important that these are visible! There are four holes in the main CCA, marked V2, V3, V6 & V7. There are four LED bezels/clips supplied with the kit. Install one bezel/clip into each hole from the top side.

Position the AB Module CCA close to the four spacers with the CCA cutout facing the front of the chassis but leave enough room so that you can maneuver and push each relevant LED into its clip. Gently push V2 LED into the V2 bezel/plastic clip until the LED clicks in the bezel/plastic clip. Repeat this for the remaining LED's marked V3, V6 & V7 and push them into their respective LED plastic clips on the main CCA.





50. Now install the AB module CCA with the cutout facing to the front of the amp, using the four spacers and 4-40 screws, see photo. Secure the AB module CCA well.

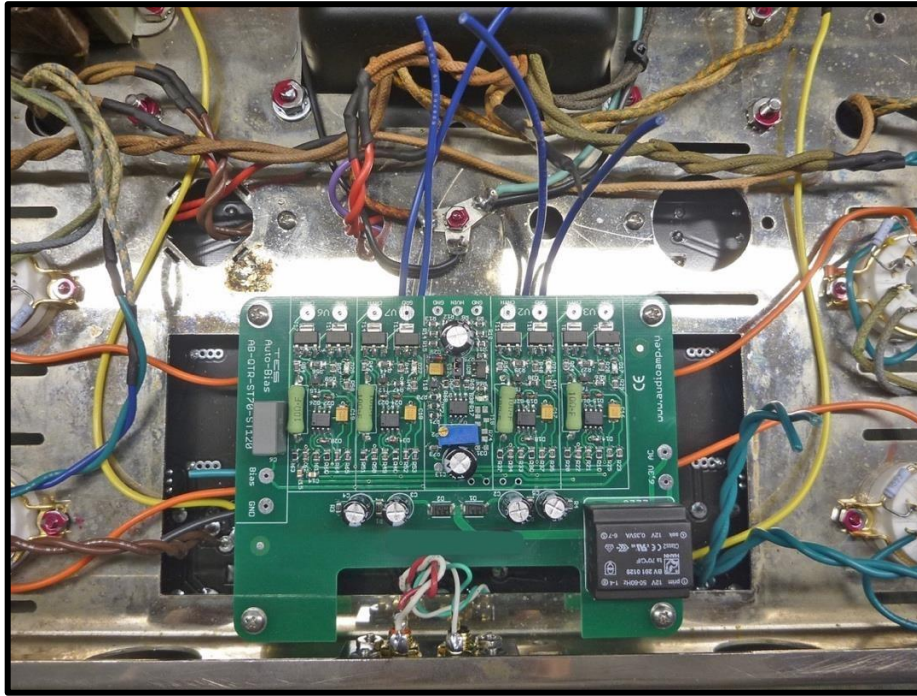
51. Connect the four blue wires as follows. Trim them so that they reach over and around the top edge of the AB module CCA with "room to spare" then strip and tin each wire, see photo.

- a- connect the blue wire from the main CCA pad AB V3 GRD to V3 GRD pad on the AB module CCA. **Do not try and fit the wires through the small holes on the pads, instead, pre tin each solder pad on the AB module and solder the wire on top of the pad, see photo on the next page. Do this with all connections to the AB module CCA.**
- b- connect the blue wire from the main CCA pad AB V2 GRD to V2 GRD pad on the AB module CCA.
- c- connect the blue wire from the main CCA pad AB V7 GRD to V7 GRD pad on the AB module CCA.
- d- connect the blue wire from the main CCA pad AB V6 GRD to V6 GRD pad on the AB module CCA.

52. Connect the black and green wires as follows. Trim them so that they reach over and around the left edge of the AB module CCA with 'room to spare,' then strip and tin each wire, see photo.

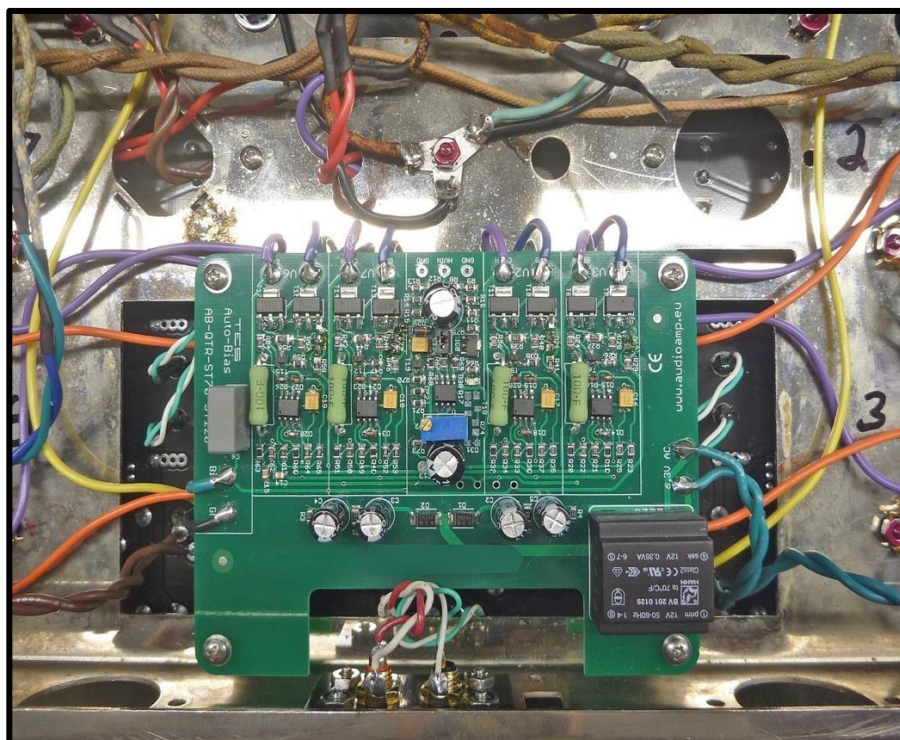
- a- Connect the black wire from the AB GND pad on the main CCA to the GND pad on the AB module CCA on the left side
- b- Connect the green wire from the AB BIAS pad on the main CCA to the Bias pad on the AB module CCA on the left side
- c- Connect the two twisted green wires from step 45-g to the 6,3V AC pads on the AB module CCA on the left side





**Mount the AB Module onto the Four Underside Standoffs**

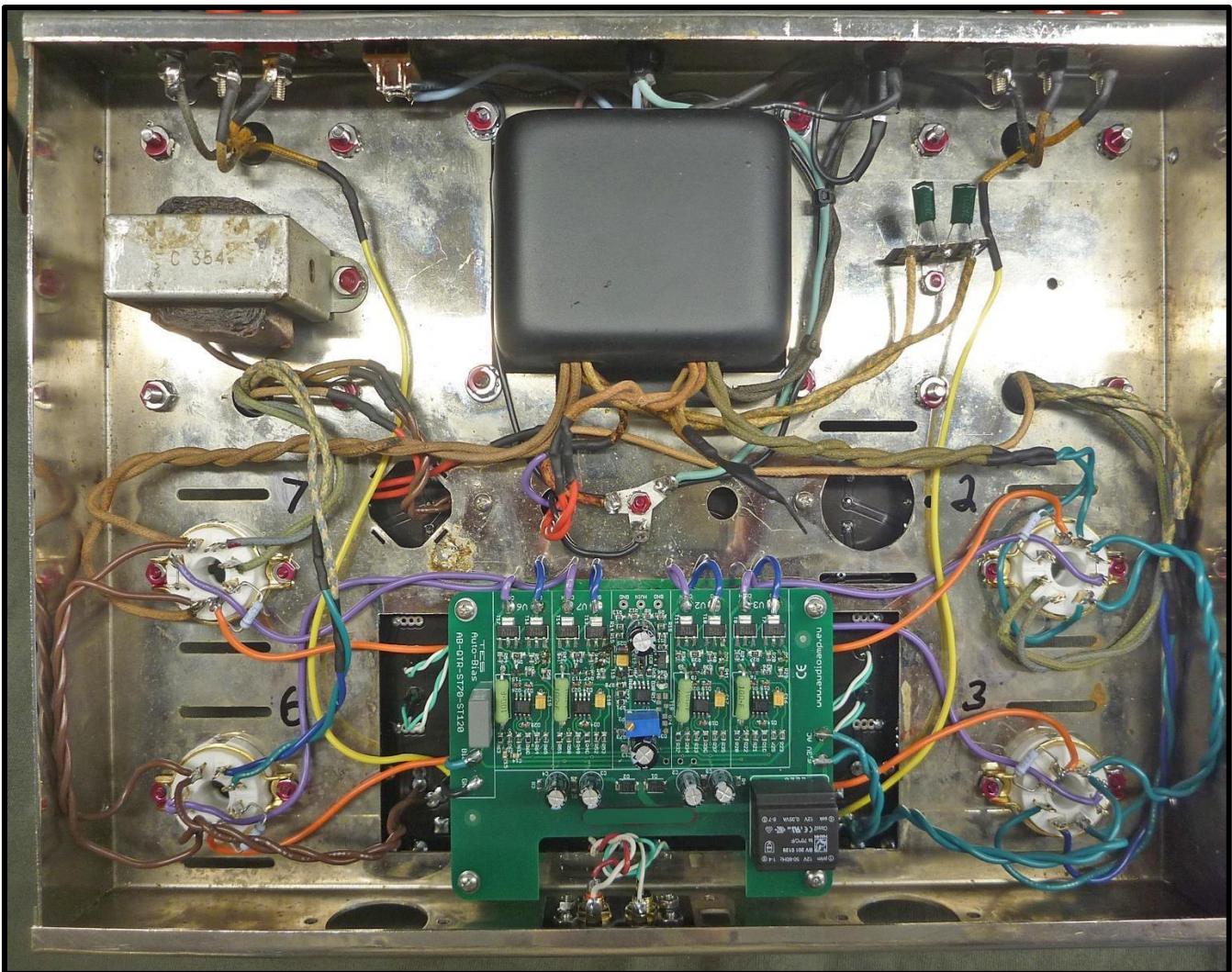
53. Cut four purple wires, two 6" and two 7", trim and pre tin both ends of each wire.
- Connect one 6" purple wire to the AB module V3 CATH pad and connect the other end to pin 1/8 on the V3 socket. **NOTE: Pins 1 & 8 should have a link between them for EACH power tube socket!**
  - Connect one 7" purple wire to the AB module V2 CATH pad and connect the other end to pin 1/8 on the V2 socket
  - Connect one 7" purple wire to the AB module V7 CATH pad and connect the other end to pin 1/8 on the V7 socket
  - Connect one 6" purple wire to the AB module V6 CATH pad and connect the other end to pin 1/8 on the V6 socket.



**Connect wires along the top, right and left edges of the AB module CCA**



This completes the chassis wiring for all the tubes, OPT's, PA-060 power transformer and CCA's. At this stage, we recommend that you check over ALL wiring, then check it again. Have a friend also verify your work if uncertain. Be sure all AC wires are twisted to keep them away from other wiring as much as possible, which will lessen the chance of noise/hum pickup. Neatly route all wiring - you DO NOT want a rat's nest of wire. If satisfied all is well, the final step is installing the new power cord.



**A Dyna-70 Ultimate Upgrade Installation with ST70 Auto Bias Module**

### **Wiring the Power Cord**

The kit comes with a 6' three-way power cord - hot/live, neutral and ground. The color code with the supplied power cord is standard for North American NEC standard: White = NEUTRAL; Black = HOT; GREEN = GROUND.

We switch the HOT/LIVE wire via the rear power switch, through the fuse and then to one of the black primary wires of the power transformer. The NEUTRAL is directly spliced to the other black wire of the power transformer. Since there is not a marked 'phase' with the power transformer, it does not matter which of the two black wires of the power transformer connects to HOT/LIVE or NEUTRAL. The GREEN ground wire is connected to the chassis star ground. If your country uses 220, 230 or 240VAC mains, make sure your ST-70 has the special PA-060 power transformer with the dual 115V primary windings, OR, you will need use a suitable step down power transformer or Variac. Use the photo's below as a guide to wiring the power cord.

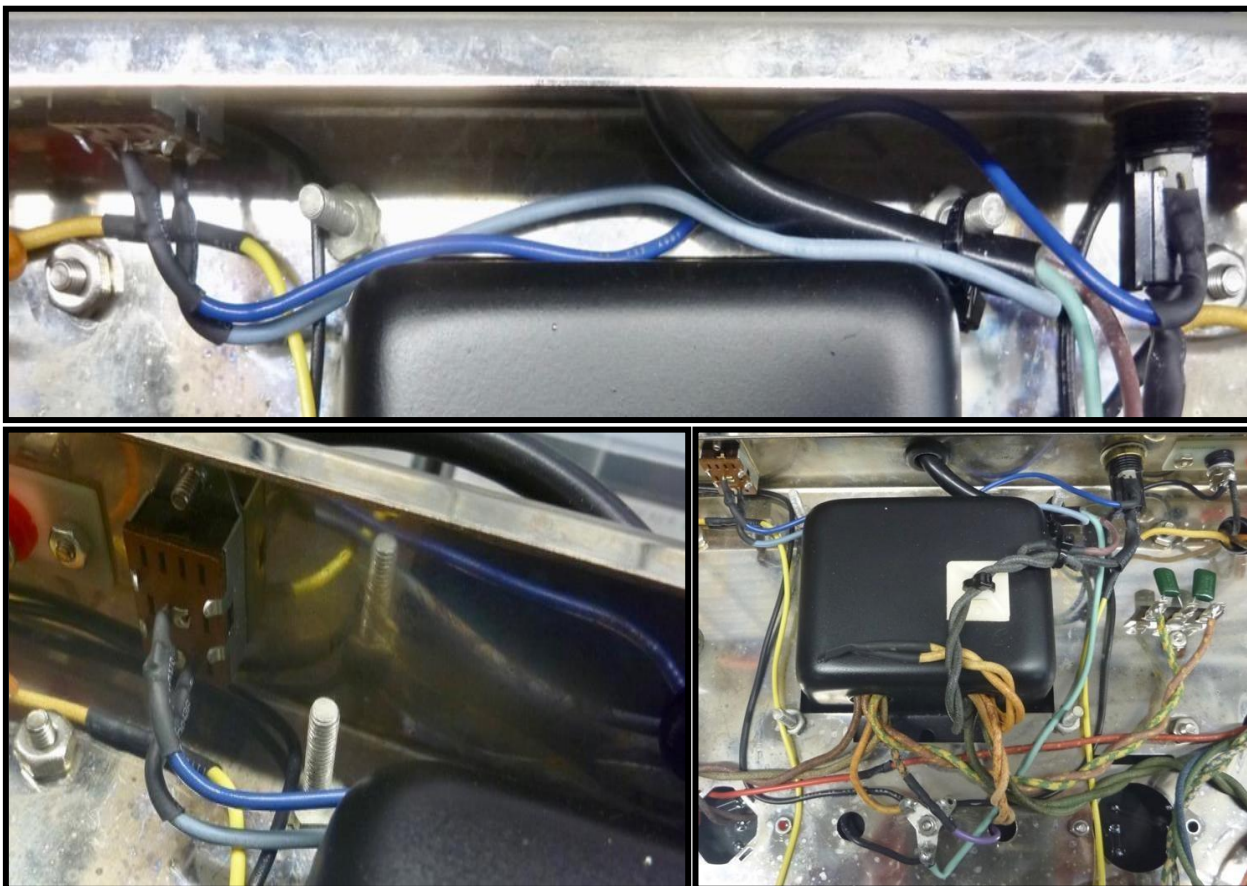
54. Remove 8"/200mm of the outer insulator of the power cord to expose the three wires.
55. Place the supplied grommet into the power cord hole in the middle of the rear of the chassis.



56. Pass the power cord through the grommet, routing it behind the power transformer until enough length of the power cord is pulled through to reach the right side screw of the power transformer. See photo.
57. Use a zip tie to tightly fix the power cord to that screw, and make sure this is a tight fit so that the power cord cannot move.



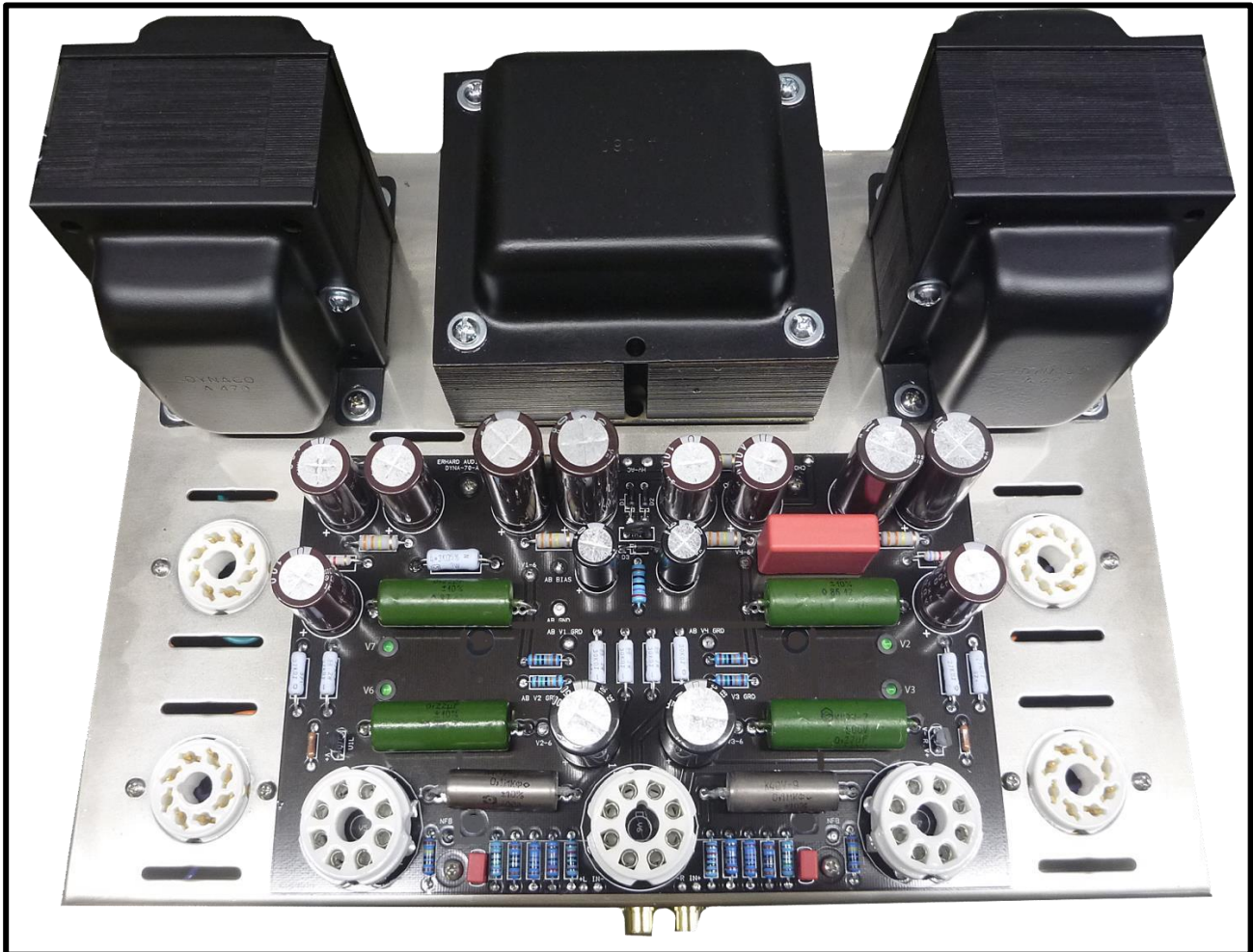
58. Route the power cord's black HOT/LIVE wire behind the power transformer and solder it to the bottom tab of the power switch. We recommend that you use heat shrink to insulate the joint.
59. Cut a 9"/220mm length of blue wire, strip one end and pre-tin with solder. Connect that end to the remaining tab of the power switch. We recommend that you use heat shrink to insulate the joint.
60. Route this blue wire behind the power transformer, then trim to length to reach the upper tab of the fuse holder and solder it to it. We recommend that you use heat shrink to insulate the joint.
61. Connect the longer black wire from the power transformers primary to the center tab of the fuse holder, and trim the wire as required. We recommend that you use heat shrink to insulate the joint.
62. Splice the other black wire from the power transformer's primary winding directly to the white NEUTRAL wire of the power cord. Trim as required.
63. Solder the green GROUND wire from the power cord to the chassis star ground.





Check the power cord wiring again, making sure you did not mix up the HOT/LIVE and NEUTRAL wire connections. Check again to make sure that the power cord secured to the power transformer screw.

This is it as far as the kit installation and wiring is concerned. If you are satisfied that all is well, we can start the powering up procedure and voltage check.



**A Completed Dynaco 70AB Ultimate Upgrade**

NOTE: The ceramic power tube sockets for the power tubes in the above photo are not included. Only the three ceramic tube sockets on the main CCA are included in the kit.

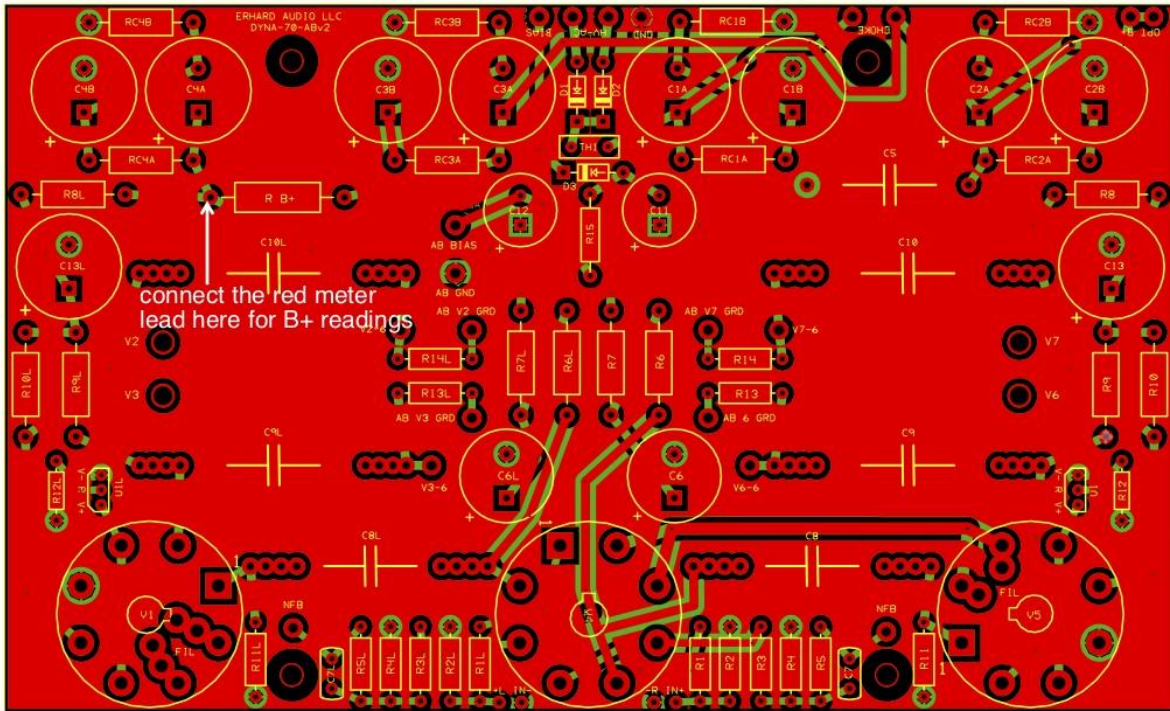
### **Power Up**

Prepare a clean bench area where you can place your ST-70 for testing and setting the bias (if manual bias CCA) or verifying bias (if using the Auto Bias Module option). We find it easiest to put the chassis on its side. See photo. Use a piece of wood or similar, and put it under the right OPT to hold the chassis upright on its side. DO NOT plug any tubes in yet - we need to ensure a steady high voltage B+.

We recommend that you use two or three digital multimeters for testing. Grab one meter and connect its black ground lead to the chassis star ground and connect its red lead to the left side of resistor R B+, ref illustration below. We use Hirschman test lead connectors. If you do not have that style, use alligator clips. It is best to be able to clip the meter leads to the various points instead of having to hold probes on high voltage test points. Set your meter to DC high voltage, 600VDC or higher.



Hirschman Test Lead Connector



Auto Bias Printed Circuit Board Illustration

Refer to the paragraph under the **Assembling the CCA** heading regarding resistor R B+. We recommend that you measure your household mains supply level at a wall outlet to determine which of the three resistor values for R B+ you should use. Once again, make sure your work area is clean and that none of the meter leads are touching anything else but the points on the CCA as described above in measuring B+.

***WARNING: You are working with extremely high AC and DC voltages. From 720VAC and close to 500VDC! Take EXTREME care, these voltages can be LETHAL!***

Make sure the rear power switch is OFF. Plug the power cord into the wall outlet. Take a deep breath and turn the amp on. The meter should immediately start showing voltage. Because no tubes are installed, the power supply is not loaded, you will get a much higher B+ reading than the unit normally operates. B+ can be anything up to 470VDC or more. It should stabilize quickly and may come down a bit before stabilizing. Keep an eye out for any smoke or unusual noises... hopefully there are none.

Leave the amp on for a couple of minutes, the B+ should stay steady. Now disconnect the red lead from R19 and its black twin from the chassis star ground. Set your meter to read AC volts, minimum 10V. Put one meter lead on pin 2 of V2 and the other lead on pin 7 of V2. You should read approximately 6.3 VAC, or close to that value.

Now put one lead on pin 2 of V6 and the other lead on pin 7 of V6. Again, you should read approximately 6.3V AC. If you get no immediate readings on either meter after you turn on the amp, power it down straight away and unplug the power cord. Allow five minutes for all the capacitors to discharge and then go over all wiring again.

If all is well after a few minutes, turn the amp off and unplug the power cord. You will see the DC voltage start to drop. Keep the meters connected as it will take a while until all the capacitors have discharged. Leave it alone for at least five minutes. DO NOT touch anything until the B+ level has dropped below 5 VDC.

### **Checking the Auto Bias and B+ levels with Tubes**

Insert the three 6SN7 signal tubes. Also plug in the left channel EL34's, V2 and V3. Even though our CCA is .08"/2mm thick, it will still flex when inserting the tubes. Therefore, when you plug in the three 6SN7 tubes, put a finger under the sockets to support the CCA and minimize flex.

### **Do Not Skip or Omit this Next Step!**

**You MUST connect a speaker or a dummy load of either 4 or 8 OHMS (Wire wound power resistor rated for a minimum of 20-25 Watts) to both left and right speaker outputs. Next, insert an RCA shorting plug into both R & L audio inputs to the amplifier.**

Connect the red lead from one digital meter to pins 1-8 on V2. Set the meter to read low DC volts, minimum 1VDC.

Connect the black lead to chassis star ground.

Connect the red lead from another digital meter to pins 1-8 on V3. Set the meter to read low DC volts, minimum 1VDC.

Connect the black lead to chassis star ground.

If you have a third digital meter, connect that to read B+ at resistor R B+ as shown in the previous PCB illustration. Connect its black lead to the chassis star ground. Set this meter to read high voltage DC, minimum 600VDC.

Plug the power cord in and turn the amp on. You should see the filaments of all the tubes illuminate. If you have a meter connected to read B+ at the left side of resistor R B+, it should hit a peak of around 440VDC, and as the two EL34 tubes start to conduct, that value will drop.

You should also see the small red LED in the center of the AB module light up, the AB module is now going through its initial startup sequence. This red LED will go out after approximately 10 seconds.

After about 30-45 seconds, the two meters connected to pins 1 - 8 of V2 and V3 should start reading a voltage of around 200mV to 300mV. The AB module is now going through its soft start sequence as well as checking each tube to finally reach the pre-set bias level. Do not be alarmed if the module temporarily raises bias above 400 mV / 0.40 V. It can go over 600mV when newly installed and powering tubes for the first time. The module is going through a calibration stage and will not do long-term damage to your tubes or the bias module, these are transients that occur quickly.

Approximately 50-60 seconds after power on, you will see the two meters connected to pins 1-8 on V2 and V3 go up to around 400mV and at approximately the same time, the green LEDs mounted in the main CCA will start to illuminate; there is one green LED for each output tube. Once the green LEDs are on, the meters connected to V2 and V3 should read around 400mV which is the pre-set bias level.

Leave the amp on for a couple of minutes, the bias LEDs should stay on and periodically check the B+ level, it should be around the 390-410 VDC. If all is well, power the amp down and give it a few minutes for B+ to drop down to 5 VDC or less. Next install power tubes V6 & V7; connect the red lead from each meter to pins 1-8 on V6 and the other meter to pins 1-8 on V7. Leave the EL34's plugged into V2 & V3. Power the amp back up. B+ should now settle to around 365-380 VDC.

Check that the single red LED illuminates at power-on and goes out after approx. 10 seconds. After 20-40 seconds, you will then see each meter connected to V6 & V7 read between 200mV to 300mV. After about 50-60 seconds, all four green LEDs should begin to come on and the meters connected to V6 & V7 should read approx. 400mV and B+ should now settle to around 365-380VDC, which is the desired operating level of B+.



If B+ does not reach to around the 365V-380 VDC mark, you may need to change the value of R B+ to reach the desired voltage range. Remove all meter leads, do a final check over, and zip tie the wires to keep them neat and tidy. When you are satisfied all is well, install the bottom cover and Tube Cage. It is now time to enjoy your 'new' Dyna-70 Ultimate Upgrade for years to come!

### ***Congratulations, you've completed the Dyna-70 Ultimate Upgrade to your ST-70 !***

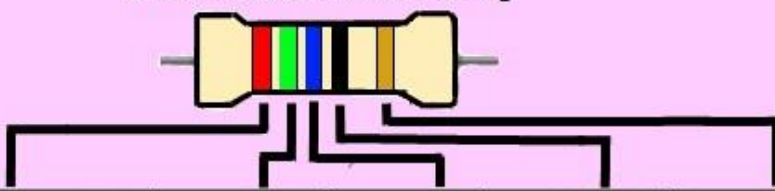
NOTE: For systems with Auto Bias, the four green LED's are a 'health' indicator of your EL34 power tubes. If those four green LED's stay on, all is well. Should any of those green LEDs either not come on, or they go out while the amp is running, is an indication that the relevant power tube/EL34 is faulty and needs to be replaced. Once a new EL34 has been plugged in, power the amp back up and make sure all four green LED's on the AB module turn on after that 50-60 seconds start up delay. No bias adjustments are required when replacing any EL34 tube. This info only applies to the Auto Bias version of the Dyna-70 Ultimate Upgrade.

***Please remember that the CCA is 'exposed' and high voltages are within easy reach. Please exercise caution and keep children and pets away from your ST-70. If you have a Tube Cage, we encourage its use for maximum safety and to protect tubes.***

### **Reference Materials**

**Resistor Color Band Code**

**5 Band Resistor Color Coding**



COLOR	1ST BAND	2ND BAND	3RD BAND	MULTIPLIER	TOLERANCE
BLACK	0	0	0	x1Ω	
BROWN	1	1	1	x10Ω	±1%
RED	2	2	2	x100Ω	±2%
ORANGE	3	3	3	x1000Ω	
YELLOW	4	4	4	x10000Ω	
GREEN	5	5	5	x100000Ω	±0.5%
BLUE	6	6	6	x1000000Ω	±0.25%
VIOLET	7	7	7	x10000000Ω	±0.10%
GREY	8	8	8		±0.05%
WHITE	9	9	9		
GOLD					±5%
SILVER					±10%

### **How to read Capacitor Codes**

Large capacitors have the value printed plainly on them, such as 10 uF (Ten Micro Farads) but smaller disk types along with plastic film types often have just 2 or three numbers on them.

First, most will have three numbers, but sometimes there are just two numbers. These are measured in Picofarads. An example: 47 printed on a small disk can is 47 Pico-Farads.

What about the three numbers? It is like reading resistor codes. The first two are the 1<sup>st</sup> and 2<sup>nd</sup> significant digits and the third digit is the multiplier value. Most of the time the last digit tells you how many zeros to write after the first two digits, but the standard (EIA RS-198) has a couple of curves that you will never see. To be complete, here are the values in a table:

Third digit	Multiplier (this times the first two digits gives you the value in Pico-Farads)
0	1
1	10
2	100
3	1,000
4	10,000
5	100,000
6 not used	
7 not used	
8	.01
9	.1

Example: A capacitor marked "104" is 10 with 4 zeros or 100,000pF which is referred to as a 0.1 uF capacitor. To confuse you more, there is a tolerance factor given by a single letter.

Example: A 103J capacitor has 10,000 pF of capacitance with +/-5% tolerance.

	Tolerance of capacitor
D	+/- 0.5 pF
F	+/- 1%
G	+/- 2%
H	+/- 3%
J	+/- 5%
K	+/- 10%
M	+/- 20%
P	+100%, -0%
Z	+80%, -20%

Picofarad (pF)	Nanofarad (nF)	Microfarad (uF)	Code	Picofarad (pF)	Nanofarad (nF)	Microfarad (uF)	Code
10	0.01	0.00001	100	4700	4.7	0.0047	472
15	0.015	0.000015	150	5000	5.0	0.005	502
22	0.022	0.000022	220	5600	5.6	0.0056	562
33	0.033	0.000033	330	6800	6.8	0.0068	682
47	0.047	0.000047	470	10000	10	0.01	103
100	0.1	0.0001	101	15000	15	0.015	153
120	0.12	0.00012	121	22000	22	0.022	223
130	0.13	0.00013	131	33000	33	0.033	333
150	0.15	0.00015	151	47000	47	0.047	473
180	0.18	0.00018	181	68000	68	0.068	683
220	0.22	0.00022	221	100000	100	0.1	104
330	0.33	0.00033	331	150000	150	0.15	154
470	0.47	0.00047	471	200000	200	0.2	254
560	0.56	0.00056	561	220000	220	0.22	224
680	0.68	0.00068	681	330000	330	0.33	334
750	0.75	0.00075	751	470000	470	0.47	474
820	0.82	0.00082	821	680000	680	0.68	684
1000	1.0	0.001	102	1000000	1000	1.0	105
1500	1.5	0.0015	152	1500000	1500	1.5	155
2000	2.0	0.002	202	2000000	2000	2.0	205
2200	2.2	0.0022	222	2200000	2200	2.2	225
3300	3.3	0.0033	332	3300000	3300	3.3	335

### Definitions / Terms / Dictionary

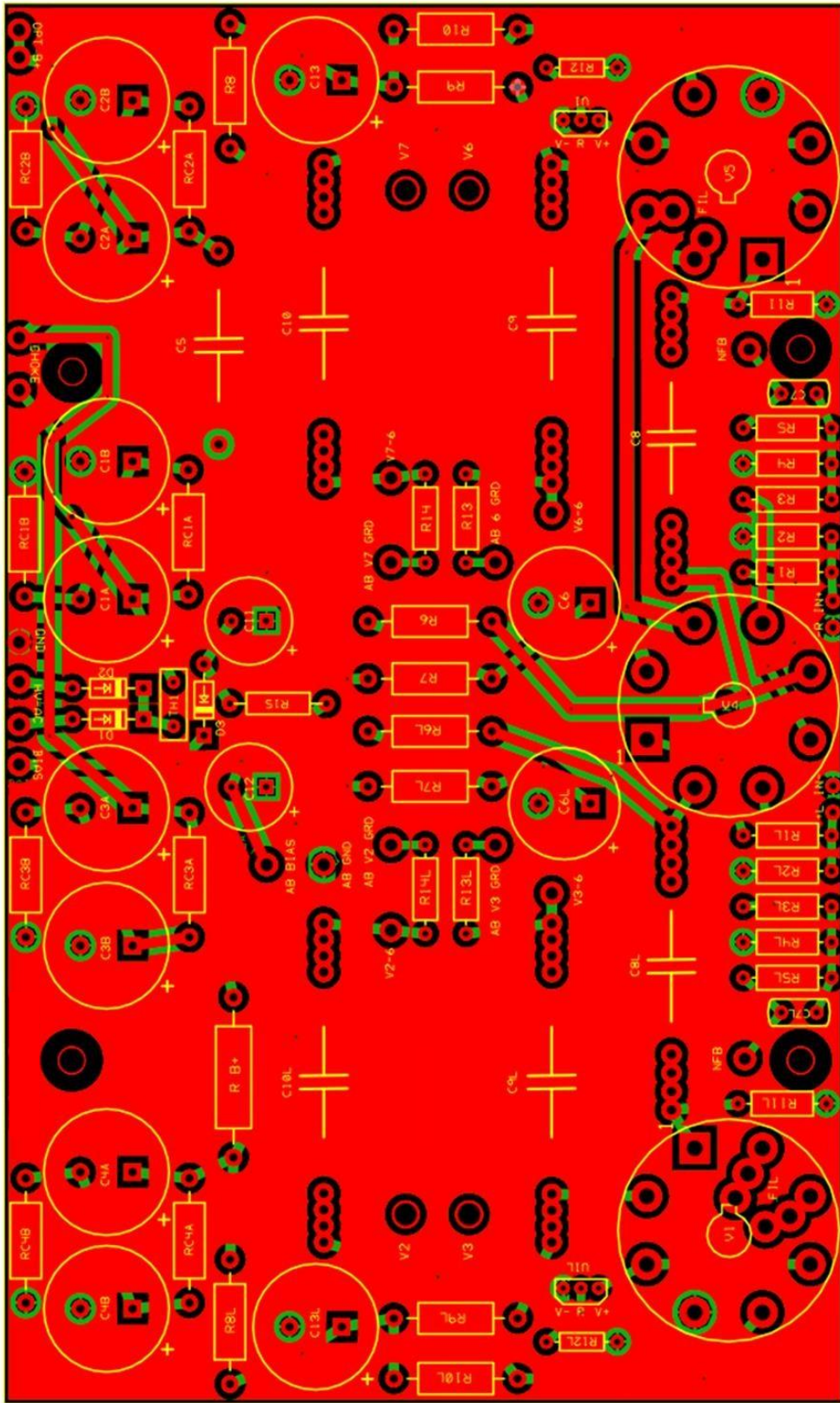
CCA- Circuit Card Assembly: A complete electronic assembly consisting of a Printed Circuit Board (PCB) that is populated with passive and active electronic components, such as resistors, capacitors, diodes, inductors, transistors, microprocessor's, inputs & outputs, etc.

PCB- Printed Circuit Board (aka Printed Wiring Board, PWB): an incomplete electronic assembly, a PCB provides or routes combinations of AC and DC voltages, analog and digital signal distribution as well as hosts electronic components. A PCB is a part of a CCA but cannot perform the function of a completed CCA. PCBs provide all interconnects between components and permits location of components on either side of the PCB.

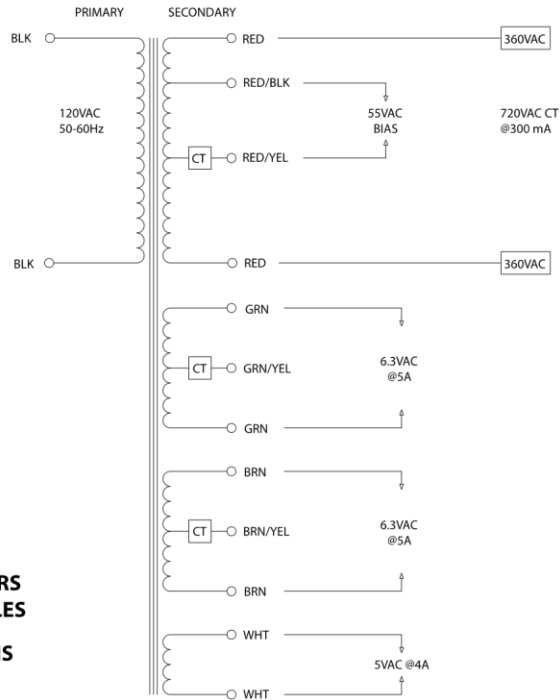
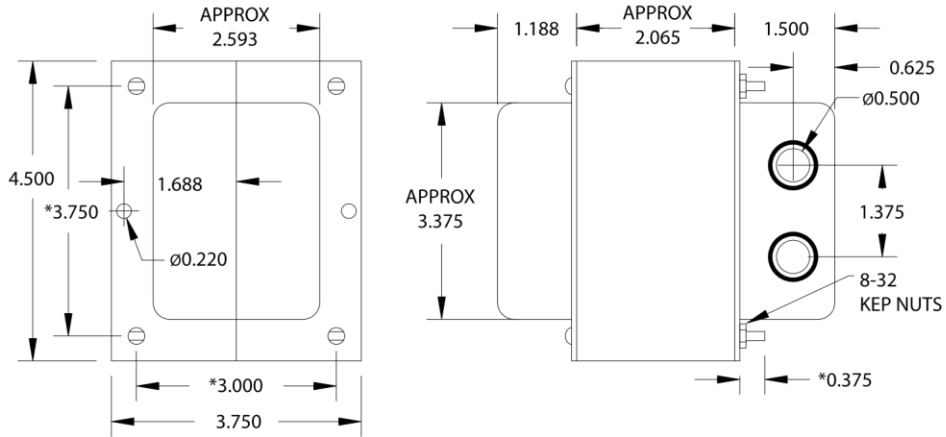


<b>Dyna-70 Ultimate Upgrade Parts List - Auto Bias</b>				
<b>Resistor</b>	<b>Value</b>	<b>Qty.</b>	<b>Type</b>	<b>Comment</b>
R1	10K 1/2W	2	Metal Film	Carbon Film Optional
R2	270K 1/2W	2	Metal Film	Carbon Film Optional
R3	1K 1/2W	2	Metal Film	Carbon Film Optional
R4	100R 1/2W	2	Metal Film	Carbon Film Optional
R5	7.5K 1/2W	2	Metal Film	Carbon Film Optional
R13, R14	150K 1/2W	4	Metal Film	Carbon Film Optional
R11	1M 1/2W	2	Metal Film	Carbon Film Optional
R12	8R 1/2W	2	Metal Film	Carbon Film Optional
R6, R7	30K 2W	4	Metal Oxide	
R9, R10	27K 2W	4	Metal Oxide	
R8	6.8K 1W	2	Carbon Film	
R15	270R 1W	1	Carbon Film	
RC1A&B thru RC4A&B	330K / 1W	8	Carbon Film	
R B+	2.2K, 3.3K, 4.3K / 3W	1ea.	Metal Oxide	See Manual, Pg. 10 & 23
RGS1 thru RGS4	1K 1W	4	Metal Oxide	Pwr. Tube, pin 5-6, V2, 3, 6 & 7
<b>Capacitor</b>				
C1A&B	100uF 400V	2	Electrolytic	A total of 6, 100uF 400V Req'd.
C4A&B	100uF 400V	2	Electrolytic	
C13	100uF 400V	2	Electrolytic	
C2A,B	180uF 400V	2	Electrolytic	
C3A,B	220uF 400V	2	Electrolytic	
C5	1uF 630V	1	Polypropylene Film	Square Film Cap
C6	100uF 350V	2	Electrolytic	
C7	220pF 400V	2	Film	
C8	0.1uF 400V	2	Polypropylene Film	Audyn*, Solen, Mundorf, PIO
C9, C10	0.22uF 400V	4	Polypropylene Film	Audyn*, Solen, Mundorf, PIO
C11, C12	100uF 160V	2	Electrolytic	
Filament Ground Caps	0.022uF 100V	2	Polyester Film	Bias Center Tap (Brn/Y & Grn/Y)
Power Switch Snap Cap	0.047 -.082uF 500V	1	Ceramic	Noise Suppression Cap
<b>Other</b>				
TH1	CL120	1	ICL	In-rush Current Limiter
U1	LM334	2	Transistor Regulator	
D1, 2 & 3	1N4004	3	Diode	
Octal Socket	8-Pin	3		Ceramic Socket for Dyna-70 PCB
Dyna-70 PCB (AB)		1	Dyna-70 v1.0 (AB)	Auto Bias PCB
Auto Bias Module (ABM)		1		AB Module
Wire & Shrink Wrap				
#4 Pan Head Mach. Screw		12		Pan Head Slotted, SS, 4-40 x 7/16
#4-40 Aluminum Stand-off		8		Al 4-40, D70 PCB & AB Module

\*Audyn std. equip. Coupling Cap



# DYNAKIT PA-060 POWER TRANSFORMER

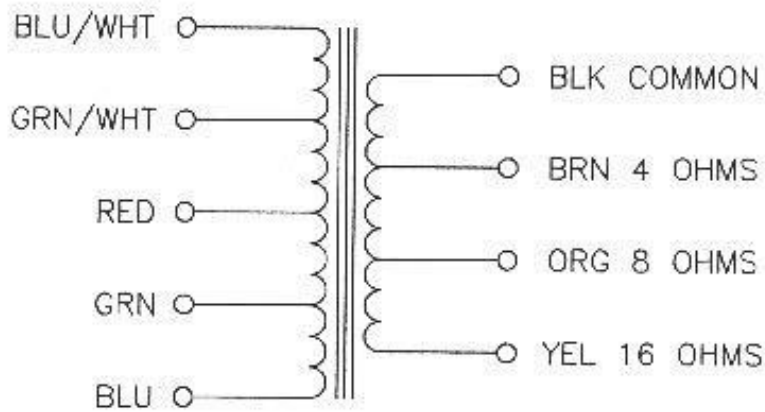
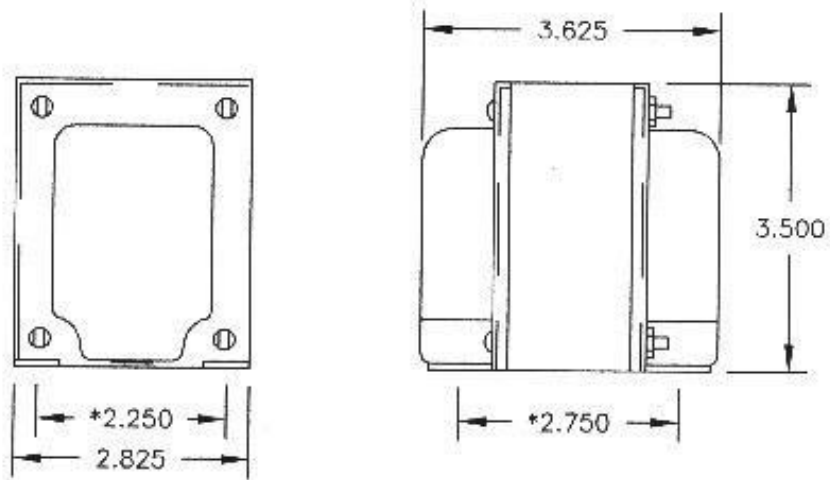


- ALL LEADS 12" LT.
- USE NYLON SHOULDER WASHERS ON COVER THROUGH BOLT HOLES
- \* DENOTES CRITICAL DIMENSIONS

For your reference, above is the diagram of the PA-060 power transformer.



# DYNAKIT A-470 OUTPUT TRANSFORMER



35 WATTS  
4300 OHMS CT

- ALL LEADS 12" LT.
- MOUNTING HOLES (SLOTS): 1/8" x 1/8"
- \* MOUNTING HOLE CENTERS

---

For your reference, above is the diagram for the A-470 OPT (Output Transformer)



## Engineering Change Notice (ECN) 002

### Thermally Compensated Surface Mount SMT-334 Regulator Dyna-70 Ultimate Upgrade Regulator Update

Part/System: Dyna-70 Ultimate Upgrade Circuit Card Assembly (Auto. & Man. Bias configurations)  
Effectivity: 27 September 2023 (original release); Revision A December 2023  
Priority: Optional; an upgrade to the Dyna-70 is not required, however it is recommended for best amplifier performance.

#### **Introduction**

This ECN addresses the operational environment of the LM-334 as utilized in the Dyna-70 Ultimate Upgrade Kit. As a part of our continuous product & process improvement efforts, Miller Audio LLC (MALLC), in conjunction with Auto Amp in Slovakia, has developed a surface mounted, thermally compensated LM-334 regulator as a replacement for the TO-92 packaged LM-334 as provided in all original Kits of the Dyna-70 Ultimate Upgrade.

This does not impact Miller Audio LLC built Dyna-70 Ultimate Upgrade ST-70 amplifiers. We build all new amplifiers with the newest and latest components in use at time of order / sale.

This new part is an upgrade over all previous LM-334 installations used on the Dyna-70 Ultimate Upgrade, and addresses the operational impacts identified in ECN001 (Ref. ECN001 for details). There is no defect or fault in the LM-334, the Dyna-70 Printed Circuit Board (PCB), the completed Dyna-70 Circuit Card Assembly, or in its design.

ECN002 introduces a new part that supersedes the original LM-334 regulator as utilized in ECN001 and all previous editions of the Dyna-70 Ultimate Upgrade. This is an optional upgrade; it is not required to continue use and enjoyment of your Dyna-70 Ultimate Upgrade ST-70 amplifier. However, we recommend that when the proper time presents itself, that all owners consider this upgrade since the new part is thermally compensated and has less impact on sound stage if amplifier has been playing for an extended period and it reaches thermal equilibrium.

With this release of ECN002, all Dyna-70 Ultimate Upgrade Kits will include this new SMT-334 in the kits at no charge.

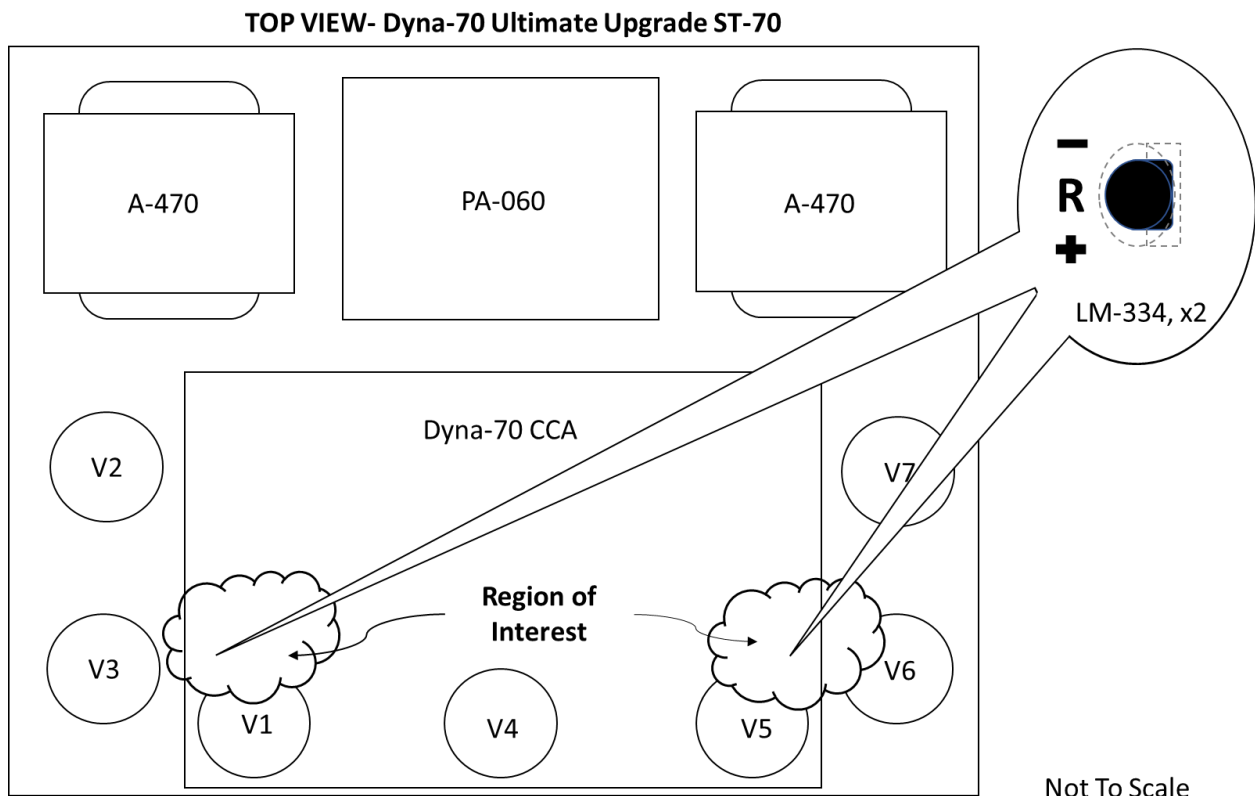
### **Background**

Recent testing in early 2023 demonstrated the LM-334 (i.e., all components in the LM134/234/334 family) exhibit thermal sensitivity (common with semiconductors) that can impart negative effects to the audio signal in the audio drive circuits in the 6SN7's for the left channel (V1) and right channel (V5) of the Dyna-70 Ultimate Upgrade Kit.

This has not been an issue with Dyna-70 upgraded ST-70's where the amplifier is operated with the tube cage removed. However, from a safety standpoint regarding children, pets, or flammable objects, MALLC recommends users keep the tube cage in place during operation of the amplifier. While a Dyna-70 modified ST-70 using the tube cage will play for long periods of time, it has been noted that changes in distortion levels increase over time due to thermal heating of the LM-334, reaching an equilibrium thermal environment that degrades sound quality and stereo image in those units where users keep the tube cage in place.

### **Engineering Analysis**

The Dyna-70 Ultimate Upgrade utilizes two LM-334 voltage regulators for the amplifier drive stage of the left and right channel 6SN7 tubes, V1 and V5. Adjacent to the V1 and V5 6SN7 signal tubes, are V3 and V6, the left and right EL34/6CA7 power output tubes. The LM-334 is in this corner between tubes V1 & V3 on the left side and V5 and V6 on the right side, reference Figure 1.



**Figure 1- Thermal Region of Interest with LM-334 Regulator**



## Action & Resolution

MALLC in reviewing preliminary findings and reviewing technical documentation from Texas Instruments on the LM-134/234/334 family of regulators, resolved that the best solution was to introduce a thermally compensated SMT-334, providing a solution that provides a more robust design and less user interaction with the amplifier (however we still suggest use of the Vornado Zippy Fabric Fan, it just keeps the whole amplifier cooler).

1. Since many owners of Dyna-70 Ultimate Upgrade use their ST-70 amplifier without the tube cage, they do not experience or notice any thermal distortion: Continue operation without the tube cage, however its suggested owners consider use of a small, quiet fan for improved air circulation across the Dyna-70 CCA.

2. For owners that operate their Dyna-70 Ultimate Upgrade with a tube cage, use of a small fan also helps to stir air circulation and convection cooling currents, lowering thermal distortion. This benefits both users who use a tube cage and those who do not use a tube cage. MALLC has measured a 30F degree decrease in LM-334 temperatures using forced air cooling from the Zippy Fan vs. no force air cooling. This did not involve use of a heat sink, but the bare, top-mounted LM-334. Use of a fan permits leaving the LM-334 in its topside location, which will also extend service life of all hot components in the amplifier.



Figure 2- Vornado Zippy Fan

NOTE: We use and can recommend the Vornado brand Zippy cloth three-blade personal fan, Figure 2. They are available at Home Depot, Amazon, Target, etc. for approximately \$25. They feature 2-speeds and are very quiet and safe to use since the blades are fabric.

3. For new builds or retrofit of the Dyna-70 Ultimate Upgrade Kit in either Automatic or Manual Bias configurations, we recommend the SMT-334 be mounted on the underside (backside) of the Dyna-70 PCB, reference following illustration, Figure 3. This follows the previous TO-92 packaged LM-334 relocation in ECN001, reducing exposure to elevated temperatures near the tubes. As described in ECN001 and this ECN, the mounting of all -334 regulators is now to be made on the underside of the Dyna-70 PCB; DO NOT mount the -334 in the topside location as originally described in the Auto Bias and Manual Bias Assembly Manuals.

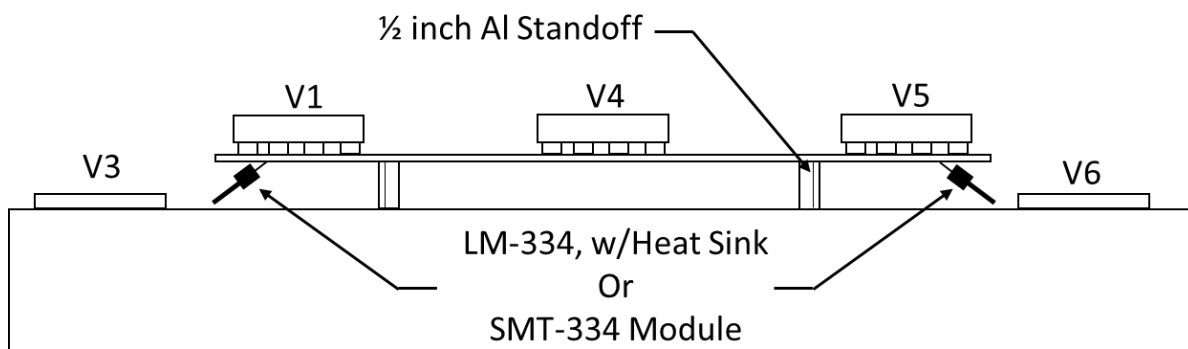
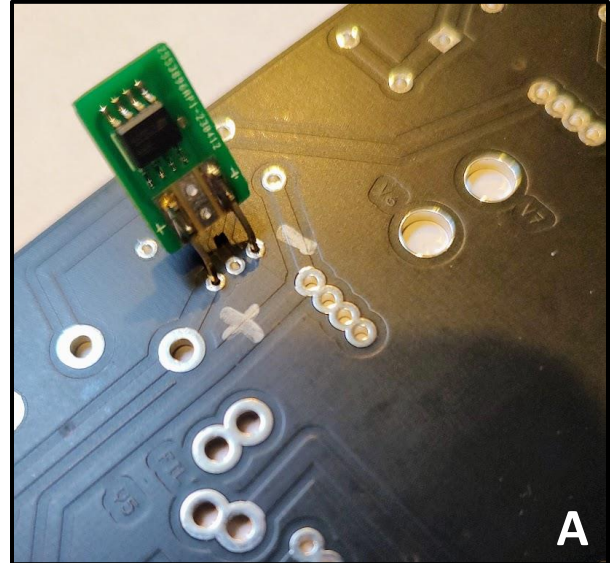


Figure 3- Front View Dyna-70 CCA with underside mounting of SMT-334; mounts in similar fashion to earlier LM-334 TO-92 package.

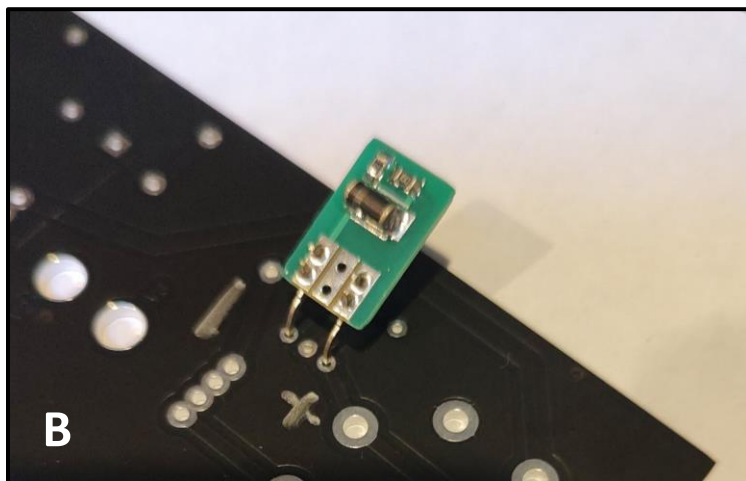
While this is not a complication for the Manual Bias version of the Dyna-70, the Auto Bias version will require more attention to detail during assembly since there are more wires that can snag and interfere with the SMT-334.

We suggest the SMT-334 be installed after all wiring between the Dyna-70 CCA and the Auto Bias CCA has been completed and before final mounting of the Dyna-70 Circuit Card Assembly (CCA), allowing for insertion of the SMT-334 from the bottom of the PCB and soldering from the top of the PCB, then trimming the remaining lead excess from the top surface of the PC board. **Pay particular attention to the polarity of the SMT-334, the markings are small on the SMT-334 and one can easily confuse the “+” sign and the negative ground arrow symbol!**

Also ensure that the SMT-334 does not contact the solder points for R12. This was not an issue in our prototype development, but if not aligned properly, it could touch one of these R12 solder locations and ground the circuit. **DO NOT let the SMT-334 or any part of the SMT-334 assembly touch any electrical connection points!** R-12 is to be removed and discarded; it is no longer required. Do not operate with SMT-334 and R-12 in-place, you must remove R-12

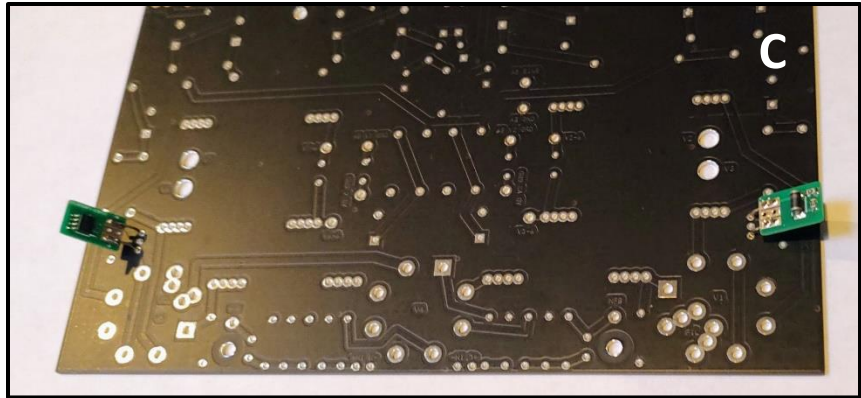


**Photo A: Underside view of Dyna-70 PCB; viewed from underside, this is the left side SMT-334 (Right side when installed face-up on amplifier). Note polarity markings on PCB and the SMT-334. The tube sockets are to the bottom left corner in this photo.**



**Photo B: Underside view of Dyna-70 PCB; viewed from underside, this is the right side SMT-334 (Left side when installed face-up on amplifier). Note polarity marking on PCB- on this side of the SMT one can not see the Positive and Negative markings on SMT-334.**

**Photo C: Underside view of Dyna-70 PCB; this is the full view of the Dyna-70 PCB. Note correct installation of the SMT-334 has the SMT334 (small black square chip) facing to the RIGHT when viewed from underside of PCB and the 6SN7 sockets are towards you as you are viewing.**



**The tubular resistor on both SMT334's will face to the LEFT when viewed from underside of Dyna-70 PCB and the 6SN7 sockets are towards you as you are viewing.**

4. For fully assembled and operating Dyna-70 Ultimate Upgrade ST-70's, owners are encouraged to remove the top mounted LM-334 and install the SMT-334 on the underside of the Dyna-70 PCB. We suggest you obtain 2 new SMT-334's - do not try to de-solder and then re-solder the same LM-334's on the underside. The components experience a long heating cycle during removal that exceeds the rated thermal time-at-temperature for the device, ruining the -334.

Users are cautioned to permit their amplifier time to cool to room temperature while ensuring that all electrolytic power capacitors have discharged. We suggest a minimum of 20-30 minutes or more to cool the amplifier and discharge the capacitors. Finally, we recommend use of an Aluminum heat sink clamp to prevent overheating of the SMT-334 during soldering into the PCB, see figure 4.



**Figure 4- Heat Sink Clamp**

#5. MALLC will update the Dyna-70 Ultimate Upgrade Kit Assembly Manuals to reflect this change.

#6. MALLC will post this ECN in its' website documentation pages for reference.

Miller Audio LLC reserves the right to make design changes, parts replacement, substitutions and specification revisions at any time without notice. If you have questions about these changes/updates, please contact us.

**END**