



# An Overview of Audio System Grounding and Interfacing

by

**Bill Whitlock, President**

**Jensen Transformers, Inc.**

Life Fellow, Audio Engineering Society

Life Senior Member, Institute of Electrical & Electronic Engineers

*Products mentioned in this educational material are used only as examples and no endorsement is intended. Product trademarks are the property of their respective owners. Permission for copying and distribution of this document, or excerpts thereof, is hereby granted, provided no charge of any kind is made for access and proper attribution is made. Entire content © 2012 Bill Whitlock, Jensen Transformers, Inc.*

Bill Whitlock, 9/4/2012

**Overview of Audio System Grounding & Interfacing**

1

An audio system is rarely a plug-and-play affair. Noises often plague the system even if everything is done according to conventional wisdom. Did the electrician screw up? Is the AC power dirty? Is the equipment to blame? Are the cables poorly shielded? This presentation will discuss the "secret" forces that drive ground loops, how they contaminate our signals, and new tools to make troubleshooting faster and easier. Among the topics will be equipment design errors that can make life miserable for installers and users, how manufacturers manipulate "specs" to deceive, how new test standards and instruments can make manufacturers honest, why expensive cables probably won't help, and things your electrician can do to reduce or eliminate problems.

## About Bill Whitlock

Bill began designing analog electronics for console-maker Quad-Eight in 1972 and subsequently held chief engineer positions at Laserium® and Capitol Records/EMI prior to joining Jensen Transformers in 1989. He's become a widely-recognized expert on power, grounding, and signal interfacing through his seminars and lectures at trade shows and universities, including MIT in 2007. He's a member of InfoComm Academy's adjunct faculty, a CEDIA certified instructor, and NSCA students voted him *Technical Instructor of the Year* in 2009 and 2010.

His landmark paper on balanced interfaces appears in the June 1995 AES Journal, which has since become the best selling issue ever printed. Other writing includes columns for S&VC and Live Sound magazines, three chapters for Glen Ballou's *Handbook for Sound Engineers*, and dozens of magazine articles and Jensen application notes.

His four patents include the InGenius® balanced input IC made by THAT Corporation and the ExactPower® waveform-correcting AC voltage regulator. He's a Life Fellow of the Audio Engineering Society and a Life Senior Member of the Institute of Electrical and Electronic Engineers. He currently does product development and customer tech support for Jensen but is available for consulting and lecturing as time permits.



Bill Whitlock, 9/4/2012

Overview of Audio System Grounding & Interfacing

2

I firmly believe that the technical concepts in this class are best taught using analogies and intuition rather than complex mathematics. In my opinion, the audio business, especially the audiophile portion, is simply awash in bullshit and bad advice! Therefore, the remedial part of my task is to debunk myths perpetuated as "tradition" among practitioners and as unintentional but often self-serving misinformation from manufacturers. **You'll find I loathe the lies, half-truths, and distortions of marketing ... particularly when they're used to exploit ignorance or desperation.**

## Thanks to Our Sponsors!

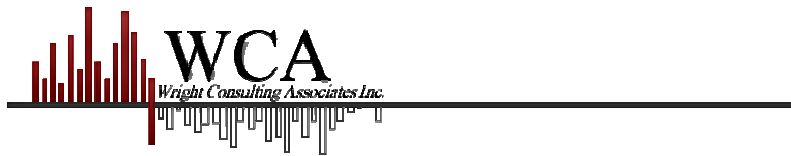

## Dedicated to Neil Muncy, Nov 1938 – Aug 2012



I first met Neil in 1994 at a local AES event in Los Angeles. He seemed to identify me right away as some one who shared his passion and he quickly persuaded me, in spite of my intense fear of public speaking, to "get out there and tell those folks what you know about balanced interfaces."

In retrospect, he was one of the most influential people in my career since he essentially kick-started my writing and lecturing. We had many lively discussions about the grounding and interfacing that spurred both of us to dig deeper and deeper. He was always kind, generous, and respectful, even when we disagreed. I have so much to thank him for. I feel very lucky to have spent several days in his Toronto home in November 2011, enjoying conversation, movies, and a party where I served as his robotic hands in the kitchen. He was a fine, warmhearted man that I'll always miss.

## Myth and Misinformation

- Do cables really “pick up” noise from the air like a radio?
- Equipment manufacturers often don’t know ground loops from **FROOT LOOPS** ... and it’s what they don’t tell you that can plague your systems!
- Basic rules of physics are routinely overlooked, ignored, or forgotten
- Overheard at a cocktail party:

*“What do you do for a living?”*

*“I design and install sound systems.”*

*“What’s so hard about that ... you just plug the stuff together, right?”*



My 20 years of customer technical support work at Jensen has given me reason to call numerous equipment makers for technical information on their products. Sometimes, “they don’t know a ground loop from a Froot Loop” is an understatement! A lecture to EE students at MIT in 2007 also confirmed that typical engineers graduate with very little understanding of the vagaries of grounding systems and interfaces!

## Physics Police Rule!



*Courtesy of Coilcraft*

Bill Whitlock, 9/4/2012

Overview of Audio System Grounding & Interfacing

6

The immutable laws of physics rule everything electric and magnetic ... period!

## What We'll Explain

- What problem noise is and how it's measured
- Why premises AC power must be wired per Code
- How subtle changes to premises AC power wiring can make dramatic differences in system noise
- How noise *actually* couples into signal paths
- How troubleshooting can pinpoint problems
- How to *safely* cure problems *without* compromising audio/video performance
- Why some so-called "cures" have little or no effect

Much of the information taught in this course is not even mentioned in modern college courses in Electrical Engineering. My lectures at MIT a few years ago reinforced this observation. Perhaps it's why noise issues have become so common in all kinds of electronic systems! Ultimately, the issues are always analog – but, sadly, analog expertise seems much less “glamorous” than digital to today's students.

## Topic Outline

- 3 – Introduction
  - Basic Circuit Theory, Terminology, Laws of Physics, and Myths
- 19 – AC Power and Grounding
  - Safety v Earth Ground, Magnetic Coupling, Leakage Current, and Voltage Drops
- 42 – Signal Interfaces and Noise Coupling
  - Balanced v Unbalanced, Equipment Issues, Cable Properties and “Floobydust”
- 99 – Troubleshooting
  - Basic Approach, Using Clues, “Dummy,” “Hummer,” and Clamp-On Meter Tests
- 122 – Solutions
  - Isolators for Audio-Video-CATV-DBS-Data, Transitions, and Power Treatments
- 212 – Suggested Reading



## Noise - Think Outside the Box

- In its broadest definition, **noise** is any undesired **signal**
- Analog **signals** accumulate **noise** as they flow through system equipment and cables
- Once noise is added, it's essentially impossible to remove it without altering or degrading the original signal
- Therefore, noise must be prevented along the entire signal path
- Signal **INTERFACES** are generally the **danger zone**, rather than the equipment itself

I'm not quite as pessimistic as the quote here, but one can't be too diligent if truly professional performance is the goal.

## Perspective on Noise Measurements

- Our ears perceive 10 dB reductions as “half as loud” and 2 or 3 dB reductions as “just noticeable”
- **Dynamic range** is the ratio, generally expressed in dB, of maximum undistorted signal to residual “noise floor” levels
- In **audio**, a dynamic range up to **120 dB** may be required for high-performance systems in typical homes
- In **video**, a signal-to-noise ratio of **50 dB** is a threshold beyond which even expert viewers perceive no improvement
- Audio hum or buzz (*stationary* noise), is much more noticeable and irritating than the hiss (*random* noise) inherent in all electronics
  - Likewise, the video hum bar is a “stationary” noise
  - Excess random noise is a gain structure issue (not discussed in this class)

Bill Whitlock, 9/4/2012

Overview of Audio System Grounding & Interfacing

10

Here, the term “stationary” refers to the spectrum of the noise. Hum and buzz have spectral content that consist of one or more frequencies that do not move – they’re stationary. The spectrum of hiss or white noise consists of countless frequencies that are “random” in nature. An excellent 1988 AES paper by Louis Fielder of Dolby Laboratories is the source of the 120 dB figure. Our ear-brain combination is very adept at separating repetitive noises like buzz from other familiar sounds that may be substantially louder in terms of sound pressure level (SPL).

## Just Say “Know” to Noise

- Sadly, applying a few simple rules or installing a “magic” device just anywhere in the signal path can’t guarantee a noise-free system
- Learning how interfaces and grounding systems work makes finding and fixing problems logical, if not always easy
- **Dumb luck** often results in acceptably quiet systems despite haphazard wiring and poorly-designed gear!
- You may find temporary relief, but the problem is still there ...

The question is not whether you can coax the system to work right today, it’s whether you’ve followed sensible practices that will allow it to continue to work right when something new is added to the system ... or the premises!

## Basic Circuits and Ohm's Law

- **Current** will only flow in a complete **circuit** (*or circle*)
  - Represented by the letter **I** in equations and measured in **Amperes**
- **Voltage** is the electro-motive force, EMF, that "pushes" the current
  - Represented by the letter **E** in equations and measured in **Volts**
- **Resistance** is the opposition to current flow (*like pinching the hose*)
  - Represented by the letter **R** in equations and measured in **Ohms**
- **Ohm's Law** tells us that  $E = I \times R$  (*and re-arranged equivalents*)
- **CURRENT ALWAYS FLOWS BACK TO THE VOLTAGE SOURCE THAT PUSHED IT!**

I hope that, for most of you, this is nothing but a few brief reminders of the Basic Circuit Theory 101 class that you took some time ago!

## Impedance

- The total **apparent** resistance of a circuit that includes capacitance and/or inductance
  - Represented by **Z** in equations and measured in **Ohms**
- It's the **functional equivalent of resistance** for AC circuits
- Unlike resistance, impedance **may change with frequency**
  - The impedance of a **capacitor** decreases with increasing frequency, becoming an open circuit at DC and a short circuit at very high frequency
  - Capacitors are measured in **Farads** and store energy in electric fields
  - The impedance of an **inductor** increases with increasing frequency, becoming a short circuit at DC and an open circuit at very high frequency
  - Inductors are measured in **Henries** and store energy in magnetic fields

Basic inductive and capacitive **reactance** principles: with increasing frequency, the impedance of a capacitor decreases while the impedance of an inductor increases.

## Impedance of Wires

- **Even STRAIGHT WIRES have RESISTANCE and INDUCTANCE**
- **Resistance**, significant **only** at DC and low frequencies, is directly proportional to length and inversely proportional to diameter squared. It's 0.015  $\Omega$  for our 10-foot #12 AWG example
- **Inductance** is directly proportional to length, but essentially unaffected by diameter or gauge
  - 4.8  $\mu\text{H}$  for our 10-foot example (straight wire)
  - Increases substantially at bends or loops
  - Typically dominates impedance at frequencies over a few hundred Hz
- Inductance is a result of the magnetic field that surrounds any conductor that carries current

A wire is modeled as a resistance and an inductance in series. At low frequencies its impedance is dominated by resistance but, above a transition frequency, the inductive reactance dominates. For heavy-gauge wire, this transition occurs at a few hundred Hz. For lighter-gauge wire, the transition is commonly in the 2 kHz to 10 kHz region. When we discuss ground wiring for lightning protection, we will again mention the increased inductance (and impedance) at bends in the wire.

### Example of Wire Impedance vs Frequency

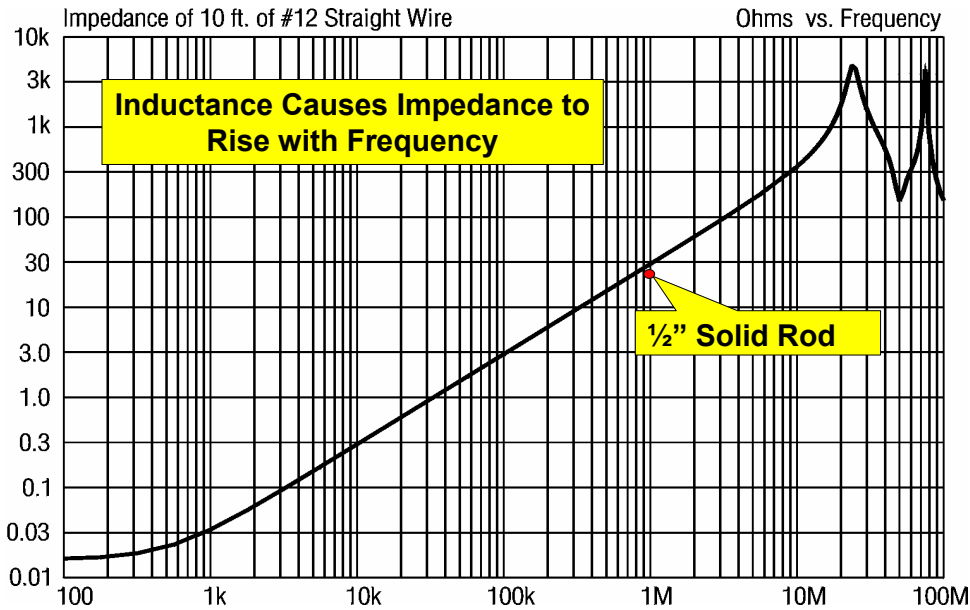

Bill Whitlock, 9/4/2012

Overview of Audio System Grounding & Interfacing

15

At higher frequencies, where inductance dominates, using thicker wire has virtually no effect on impedance. At 1 MHz, replacing the #12 wire with a 1/2" solid copper rod has little effect (as noted in the plot).

## AC Magnetic Fields and Magnetic Induction

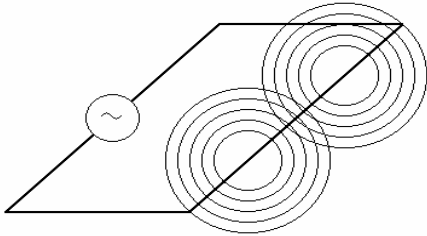

Fluctuating field surrounds every wire carrying AC **current**

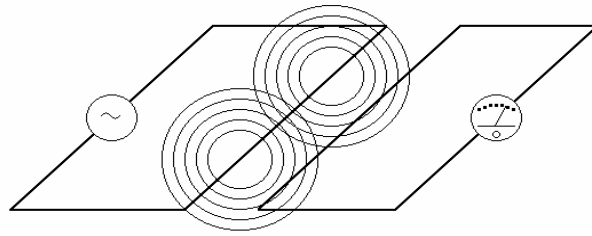

Field **induces** AC **voltage** in any nearby conductor (transformer principle)

The principle of **magnetic induction** per Michael Faraday. He is one of my heroes because, although he was scorned by the “math snobs” of his day for not publishing complex mathematical expressions of his findings, he made truly fundamental discoveries about the relationship between electricity and magnetism.



## What Does “Ground” Mean

- Also known as “Earth” in the rest of the world
- **Utility Power:** an actual electrical connection to **SOIL**
- **Electronics:** a common return path for various circuits, *whether or not actually connected to soil*
- **A FANTASY invented by engineers to simplify their work**
  - **The “uni-potential” fantasy assumes all ground symbols in schematics are at exactly the same voltage**
  - Truth: Real-world conductors have resistance, causing small voltage drops
  - Truth: Ground circuits most often serve, either intentionally or accidentally, more than one purpose
- Meaning has become vague, ambiguous, and often quite fanciful

The use of ground symbols in schematic diagrams (actually just a convenience for avoiding more lines in the drawing) lulls us into thinking that they’re all at the same potential. That’s the essence of the fantasy ... but far from the truth. Until room-temperature super-conductors become a common reality, “grounds” are connected by wires, PCB traces, or sheets of metal – all of which have both resistance and inductance. So much for the fantasy!

## Misguided Strategies

- Reduce unwanted ground voltage differences by “shorting them out” with massive wires or bus-bars
- Reduce noise experimentally by finding a “better” or “quieter” ground
- Skillfully route noise to an **earth** ground, where it disappears forever!
- Is an **earth** ground for electronic systems really necessary? Think about aircraft electronics ...



Bill Whitlock, 9/4/2012

Overview of Audio System Grounding & Interfacing

18

Random experimentation with grounding connections is the worst possible way to solve the problems. Not only is little learned in the process, but the experiment can be lengthy ... usually ending only when someone says “**I can live with that.**” The idea that “mother earth” will simply absorb noise is often called the “**sump theory**” of grounding. And when was the last time you saw an airplane dragging around a ground wire?

## Common Myths

- **Earth ground is the absolute zero-volt reference**
  - Fact: Many unintentional currents flow in soil and create voltage drops just as in any other resistance – soil is a relatively poor electrical conductor
- **Ground wires have zero impedance**
  - Fact: Wires have impedance and cannot make multiple points in a system have an identical “zero-volt reference”
- **Noise (voltage) exists on a single wire or at a single point**
  - Fact: Voltages can exist only **between two points**
  - **All voltages are relative or differential**
  - **Voltmeters have two probes ...**
  - Always ask “**Voltage with respect to what?**”



Note that voltmeters invariably have **two** probes! All voltage readings are differential ... even between two “ground” points. And you don’t put one of the probes in your pocket when you take readings.

## Connections Creating Soil Currents

- Grounds at utility power poles and towers
- Buried metal pipes (water, gas, waste)
- Ground electrodes at buildings
- Ground is tied to neutral at each location shown
- **Voltage drop of neutral wires applied to soil**
- Forms complex network of soil currents

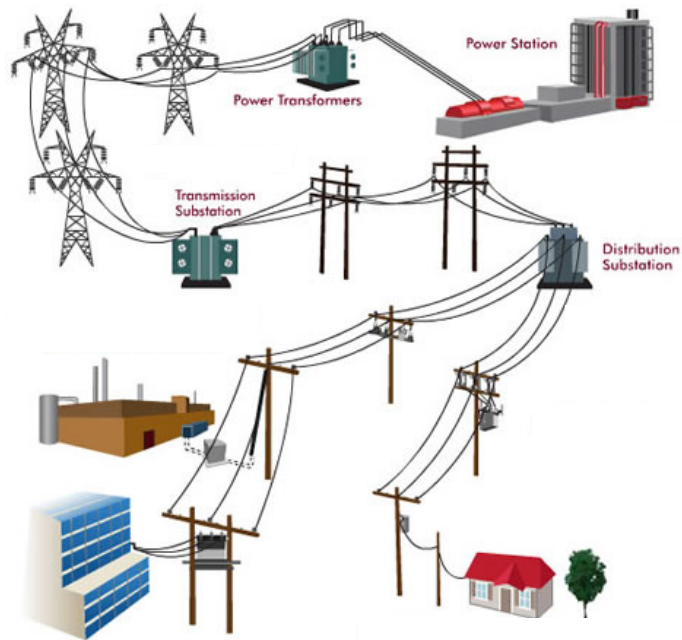

Bill Whitlock, 9/4/2012

Overview of Audio System Grounding & Interfacing

20

Gas and water pipes are required by **National Electrical Code**<sup>®</sup> (hereinafter referred to as **NEC**) to be connected to electrical power feeding the building ... making the soil and/or the pipes a pathway for currents that flow from building to building. We'll show a slide about that toward the end of the class.

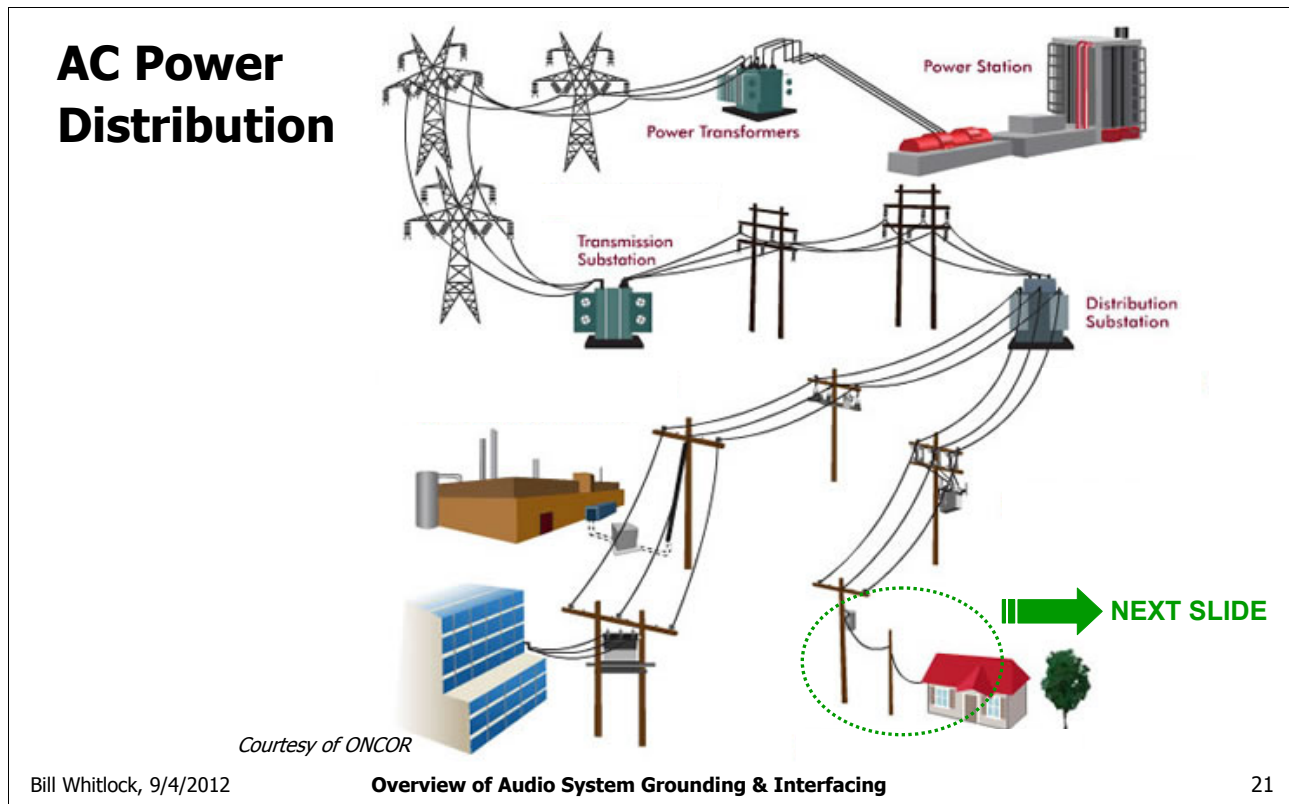

Gas and water pipes are required by NEC to be connected to electrical power feeding the building ... making the soil and/or the pipes a pathway for currents that flow from building to building. We'll show a slide about that toward the end of the class.

## Delivery of Utility AC Power

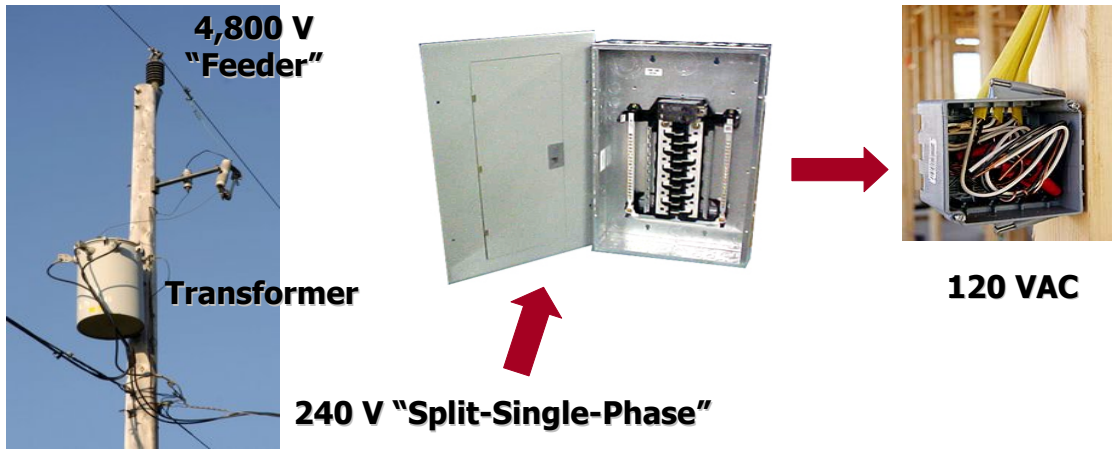

Normal residential utility power in North America is properly referred to as **split-single-phase** power.

## The 3-wire System

- NEC requires 120-volt AC premises power distribution using a 3-wire system (since about 1960)
- **LINE** (black) and **NEUTRAL** (white) are intended to carry **LOAD** current, typically up to 15 or 20 A in branch circuits
- The "safety" **GROUND** normally carries no current
- **NEUTRAL** and **GROUND** are **bonded** only at the main panel

**NEC PROHIBITS NEUTRAL TO GROUND CONNECTIONS ANYWHERE ELSE**

NEUTRAL BUS  
N-G BOND LINK

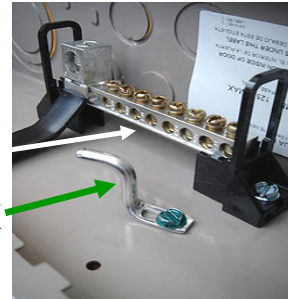

When new sub-panels are installed, a frequent electrician mistake is connecting the N-G bond. This will be discussed later ...

## Normal Current in Branch Circuit

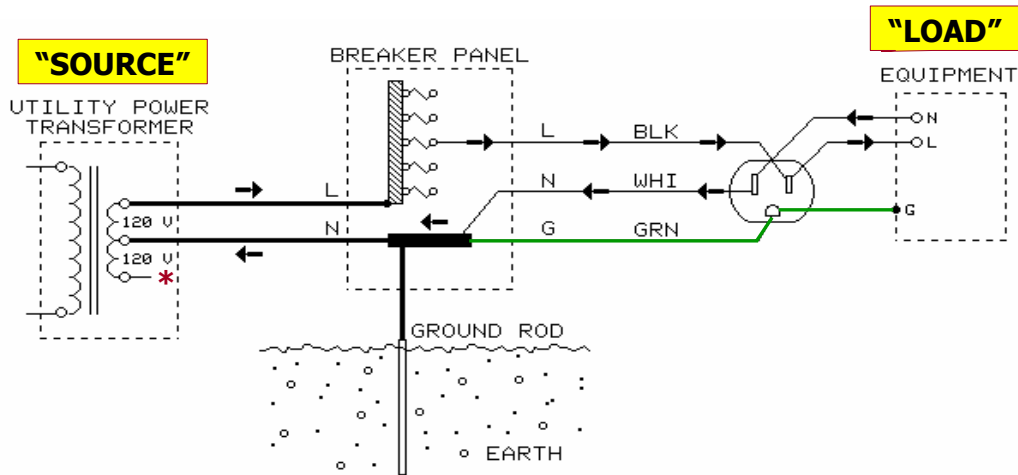

\* For clarity, meter and other "phase" not shown

**None of the load current flows in either safety ground or earth ground. All load current flows back to its source, which is the utility company's transformer! Remember, current always flows back to the voltage source, whether through an intentional or unintentional path. Electrons don't care ... they don't read schematics!**



## Grounding for Life Safety



- Exposed conductive parts (including signal connectors) can become “energized” at 120 volts if the equipment develops certain internal defects
- **Insulation** is used in power transformers, switches, motors and other internal parts to keep the electricity where it belongs
- Insulation can and does fail, effectively connecting “live” power to exposed metal – this is called a **FAULT**
- Without equipment **safety grounding**, people can be seriously shocked or electrocuted!

**It's extremely important to understand the intent of the safety ground system!**

## Fault Current Trips Breaker

- Grounding wire in a power cord connects equipment's exposed metal to safety ground via 3-prong plug
- Outlet safety ground returns via green wire or metallic conduit to **neutral** at main panel
- Low-impedance connection causes high fault current, which trips breaker *quickly!*
  - **Typical fault currents range from 150 A to over 1,000 A**
- **Safety grounding must return to NEUTRAL – THE EARTH GROUND CONNECTION IS IRRELEVANT!**

The impedance of earth ground is far too high to cause enough circuit current to trip a circuit breaker.

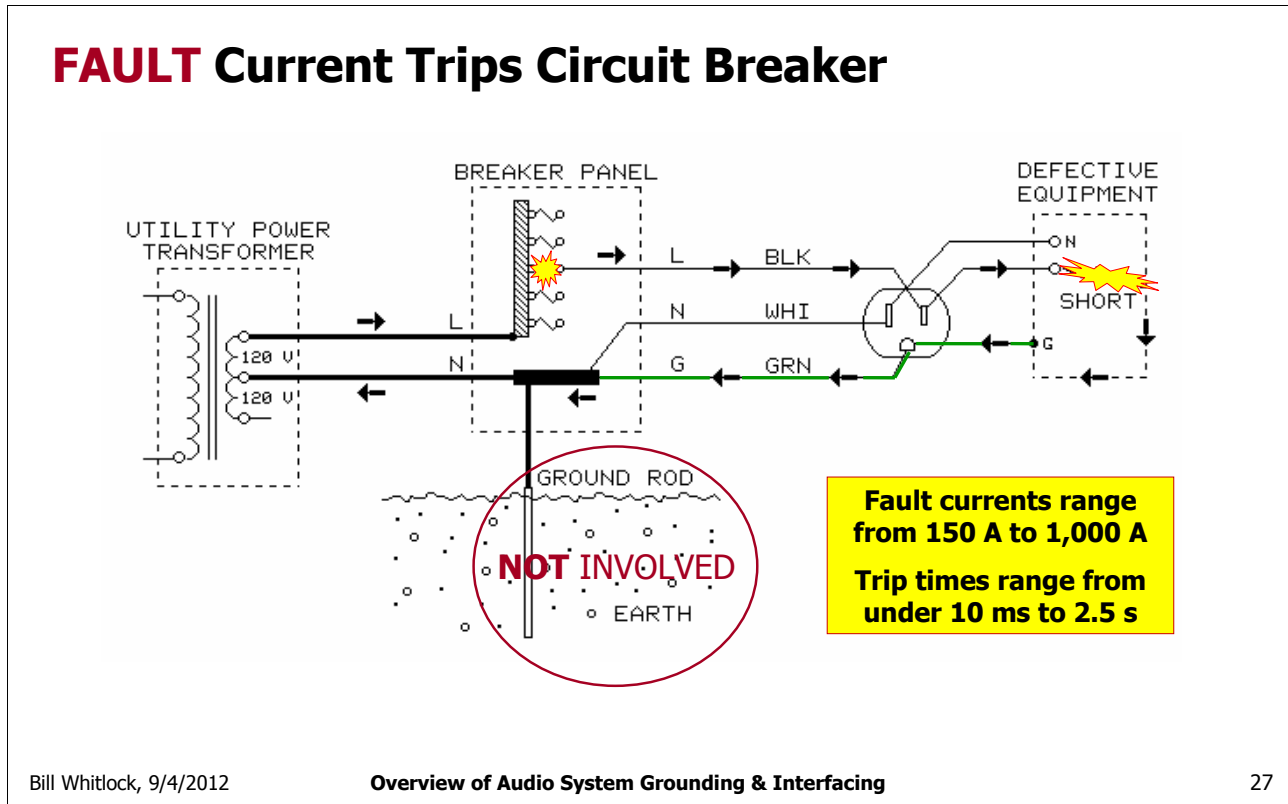

The quoted range of fault currents and trip times is based on a UL study (circa 2003-2005) of over 1,000 residential 15A and 20A outlets.

## Earth Ground is for **LIGHTNING**

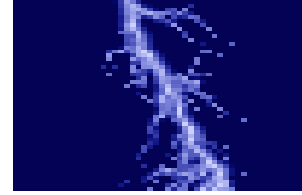

- Power lines are frequent targets of lightning
- Before NEC required grounding of power lines, they often guided lightning strikes directly into buildings!
- Power distribution lines are grounded at intervals
- Ground rod impedance is low enough to control lightning
- **NEC requires protection of *every* line that penetrates a building**

Lightning involves voltages in the hundreds of millions and currents ranging from 5,000 to 150,000 amps (an average strike is about 20,000 amps), briefly unleashing incredible amounts of power. Neighborhood distribution power lines are typically grounded at least every 1,500 feet.

## Earth Ground Rod is **Useless** for Fault Currents

**Circuit Breaker Will NOT Trip!**

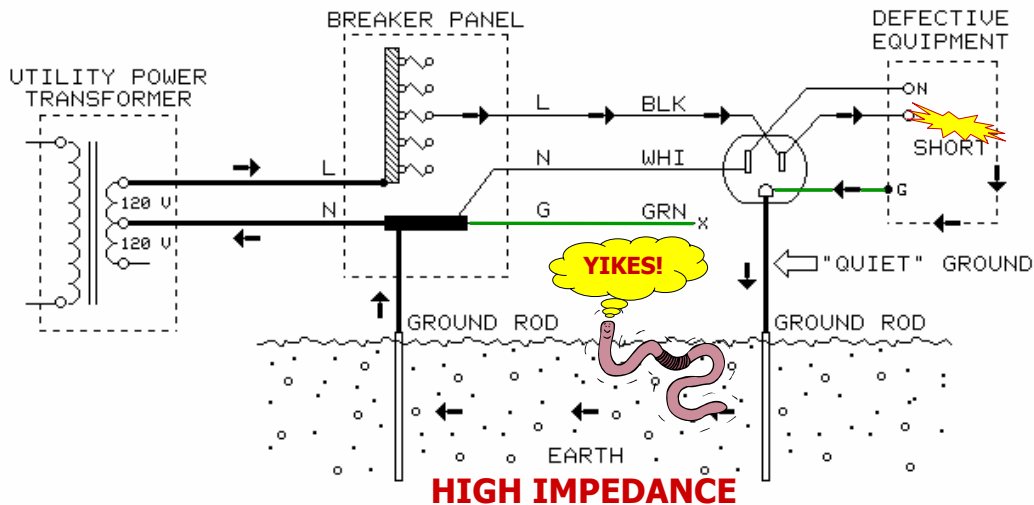

Bill Whitlock, 9/4/2012

Overview of Audio System Grounding & Interfacing

29

Its connection to earth is not what makes "safety ground" safe ... its the connection to neutral. The impedance of the soil between the ground rods could be 25 ohms, causing less than 5 A to flow through the circuit breaker. The chassis of the defective equipment would remain at nearly 120 volts – a lethal shock hazard. A few years ago, the author attended a product training session for a maker of power conditioners where the "engineer" actually advocated this technique to provide "quiet ground" to an audio listening room! He was subsequently barred from instructing at that trade show – after I reminded them of their legal liability.

## NEC Grounding Rules

- During lightning events, thousands of volts can be induced between separate rods
  - Can cause serious damage to any equipment that bridges them
- Telephone lines per NEC Article 800
  - Telco NIU protector and its ground connection must be as close as practicable to point of entry
  - Use insulated, listed wire no smaller than #14 AWG
  - Bond to main power grounding electrode if within 20 feet
  - If not, use separate 5-foot ground rod **and bond to utility power ground with #6 AWG or larger wire**
  - Wiring should be as straight as possible, using gentle curves rather than sharp bends, and physically protected (PVC conduit is preferred)
- CATV has similar, but not identical, rules (only summarized here)

Soil has relatively high impedance, allowing very large voltages to develop during even a modest lightning strike to one of them. PVC conduit is preferred because steel would increase the inductance of the wire within, raising its impedance. The #6 bond wire helps protect against power lines that fall onto telephone lines (due to an auto accident, for example) by completing a path back to the utility power neutral. Sharp bends in the wire raise its inductance, therefore making it less likely to contain the strike energy ... it may jump out of the wire at the bend and strike something (or someone) nearby.

## The “Conduit Transformer”

- **This finally explains what drives 99% of all ground loops!**
- Load current in line and neutral produces opposing magnetic fields since instantaneous current flow is in opposite directions
- Imperfect cancellation **magnetically induces** voltage over the length of the nearby safety ground conductor
  - Strongly affected by geometry and proximity of wires
  - Highest voltages with randomly positioned wires in conduit
  - Lower voltages with uniform geometry of Romex®
- Voltage is directly proportional to **load current, wire length, and rate of change in current** or  $\Delta I/\Delta t$ 
  - Mechanism favors high-frequency harmonics of 60 Hz
  - For constant current in L and N, induced voltage rises at 6 dB/octave

The favoring of higher harmonics of 60 Hz is why we usually hear “buzz” more often than the more fundamental 60 Hz “hum” and why light dimmers have such a horrible reputation for “causing” noise problems.

## Magnetic Fields in Romex®

**Current in L and N are equal but flow in opposite directions**

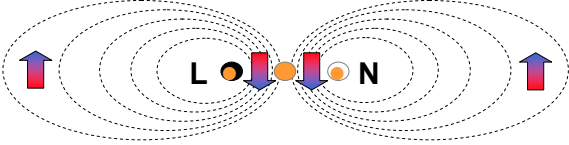

**Safety Ground "Sees" Zero Magnetic Field at Exact Midpoint**  
*(cross-section view)*

*Instantaneous L and N currents are flowing into page and out of page*

Bill Whitlock, 9/4/2012      Overview of Audio System Grounding & Interfacing      32

There is a **magnetic "null zone"** exactly midway between line conductors



# The "Conduit Transformer"

**Wires randomly positioned in conduit produce the worst possible results!**

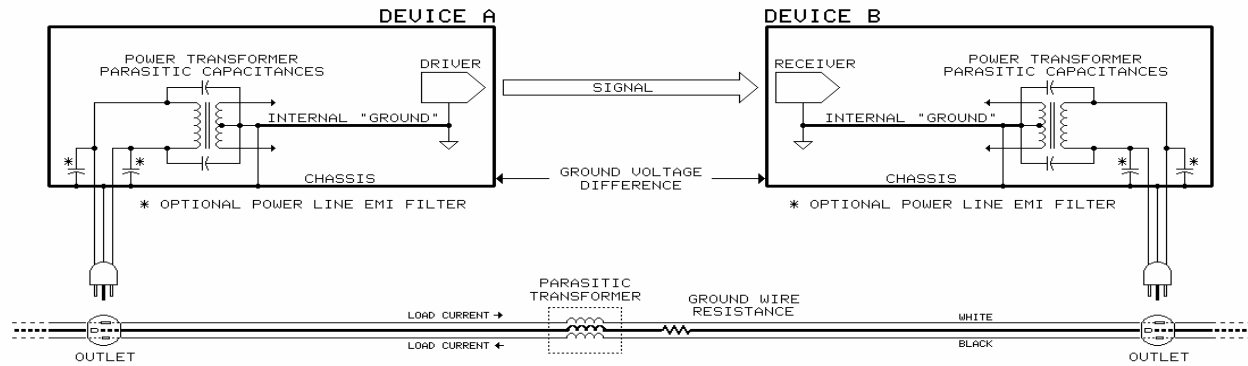
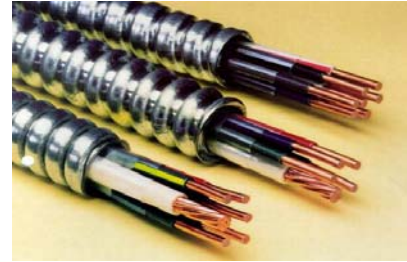

Bill Whitlock, 9/4/2012

Overview of Audio System Grounding & Interfacing

33

**The "elephant" that's been in the room for years but, until recently, unrecognized as THE major driving force behind ground loops!** This author, and my co-author Jamie Fox, presented an AES paper on this subject in November 2010.

## How the Tests Were Performed

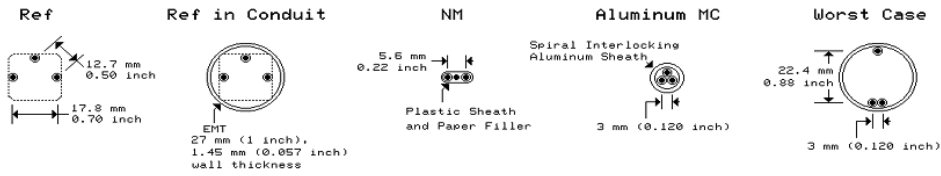
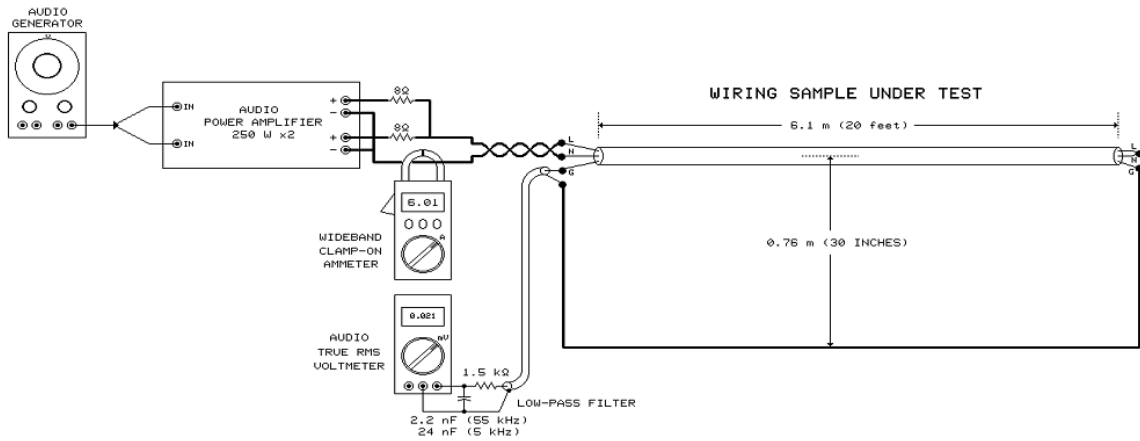

Bill Whitlock, 9/4/2012

Overview of Audio System Grounding & Interfacing

34

Excerpt from "Ground Loops: The Rest of the Story" by Bill Whitlock and Jamie Fox, a paper presented 5 Nov 2010 at the AES 129<sup>th</sup> convention in San Francisco. Available from AES as preprint #8234.

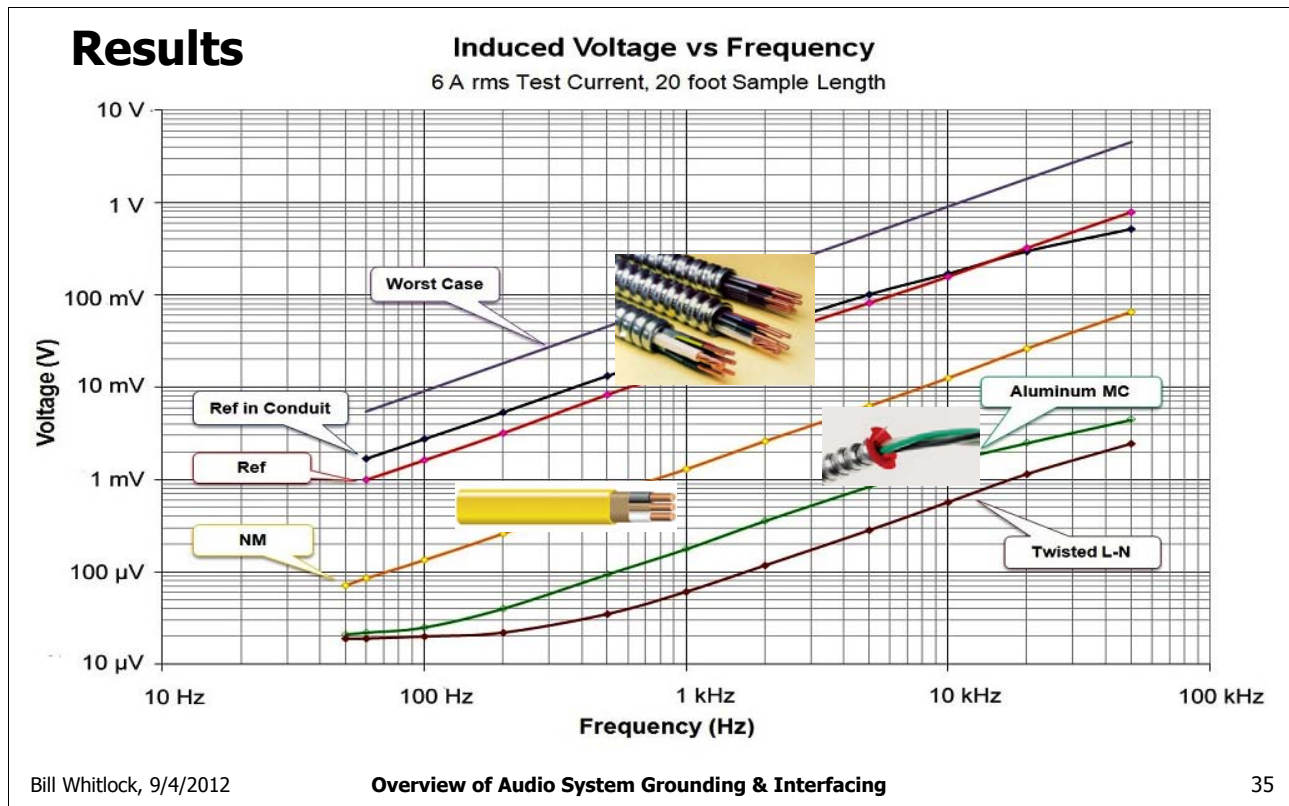

Excerpt from AES paper **Ground Loops: The Rest of the Story** by Bill Whitlock and Jamie Fox, presented 5 Nov 2010 at the 129<sup>th</sup> AES convention in San Francisco. Available from AES as preprint #8234.

## AC Power is Not Just 60 Hz

- Many loads, especially “brute force” electronic power supplies, draw current in pulses only at the peaks of the voltage during each cycle
  - “Power Factor Corrected” or PFC power supplies alleviate this problem
- 120 VAC waveform distortion is typically 2% to 6% THD
- High harmonics are created by sudden current changes
  - Typical low-cost light dimmers have a current risetime of about 5  $\mu$ s, producing strong harmonics to at least 70 kHz!
  - The conduit transformer favors those harmonics and couples them into safety ground wiring

**And the most notorious generator of fast current changes is ... *drum roll* .....  
LIGHT DIMMERS!**

## High-Frequency Noise Sources

- **Phase-control light dimmers** →
- Fluorescent lamps
- Electronic power supplies
- Arcing switches, relays, or motors
- Power-line corona discharge
- AM radio power line pickup

In the frequency domain, this risetime creates very strong harmonics up to 70 kHz.

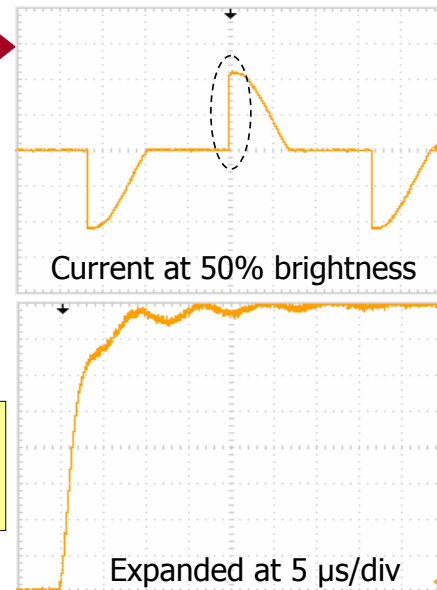

Now you can see why a light dimmer is at its worst (noise wise) when set for 50% brightness – the line voltage is at maximum when it “snaps” on (taking only about 5 us). This was a Lutron “Skylark” dimmer operating with its full rated load of six 100 W incandescent bulbs. Scale in upper oscilloscope image is 4 A/div.

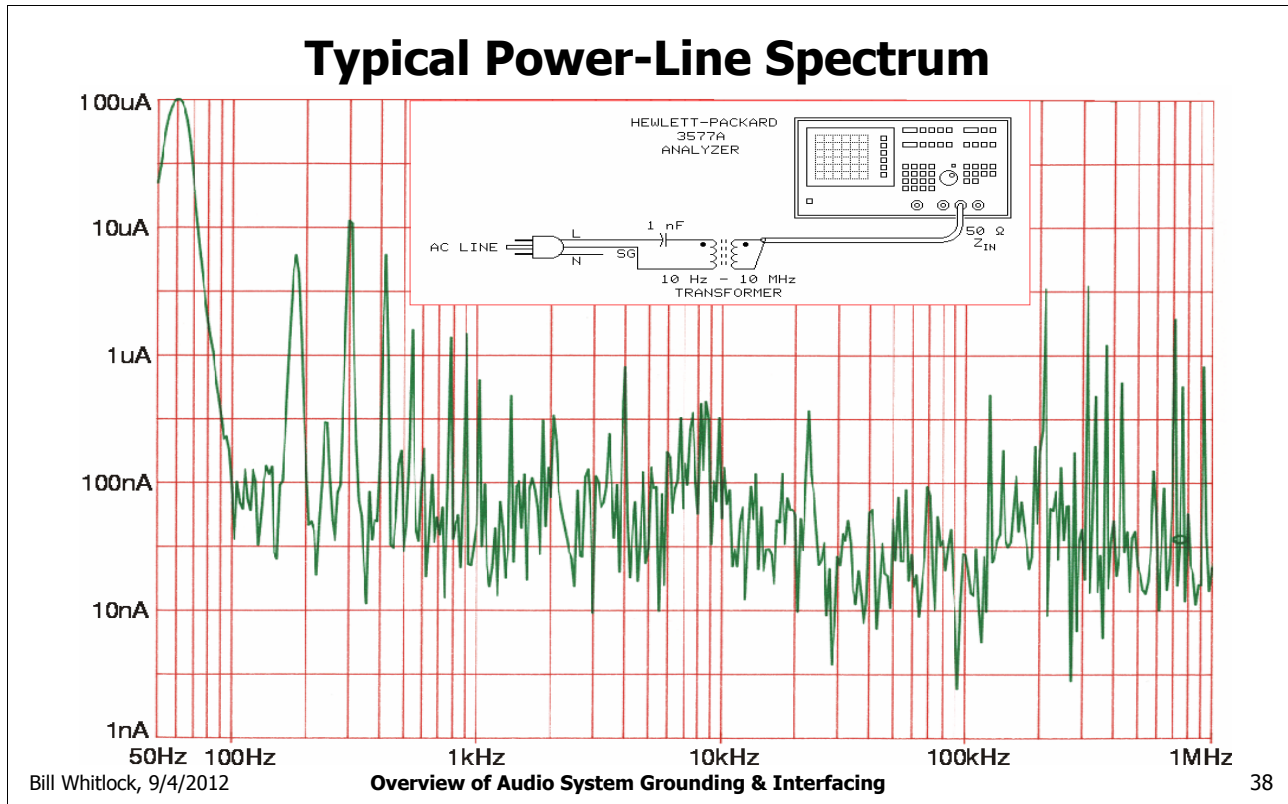

An actual spectrogram of power-line AC leakage current through 1 nF of parasitic (coupling) capacitance. Measured at a former location of Jensen Transformers in a light industrial area of Van Nuys, CA. No light dimmers were operating, but most lighting was conventional fluorescent and several pieces of office equipment and test instruments were running – manufacturing was in another building at the time.

## Parasitic Capacitances

- Exist in all real equipment connected to AC power
  - Transformer winding to winding (not shown in schematics)
  - Internal EMI filters
- Capacitances cause **leakage current** to flow from power line to chassis in real-world equipment
  - UL established safety limits for "listed" equipment 
    - 3.5 mA for devices with 3-prong plugs
    - 5 mA for devices with 3-prong plugs and a special warning label
    - 0.75 mA for devices with 2-prong plugs

**5 mA is a shock that's very unpleasant, but not life-threatening.** 0.75 mA, as mentioned earlier, results in just a tingling sensation.

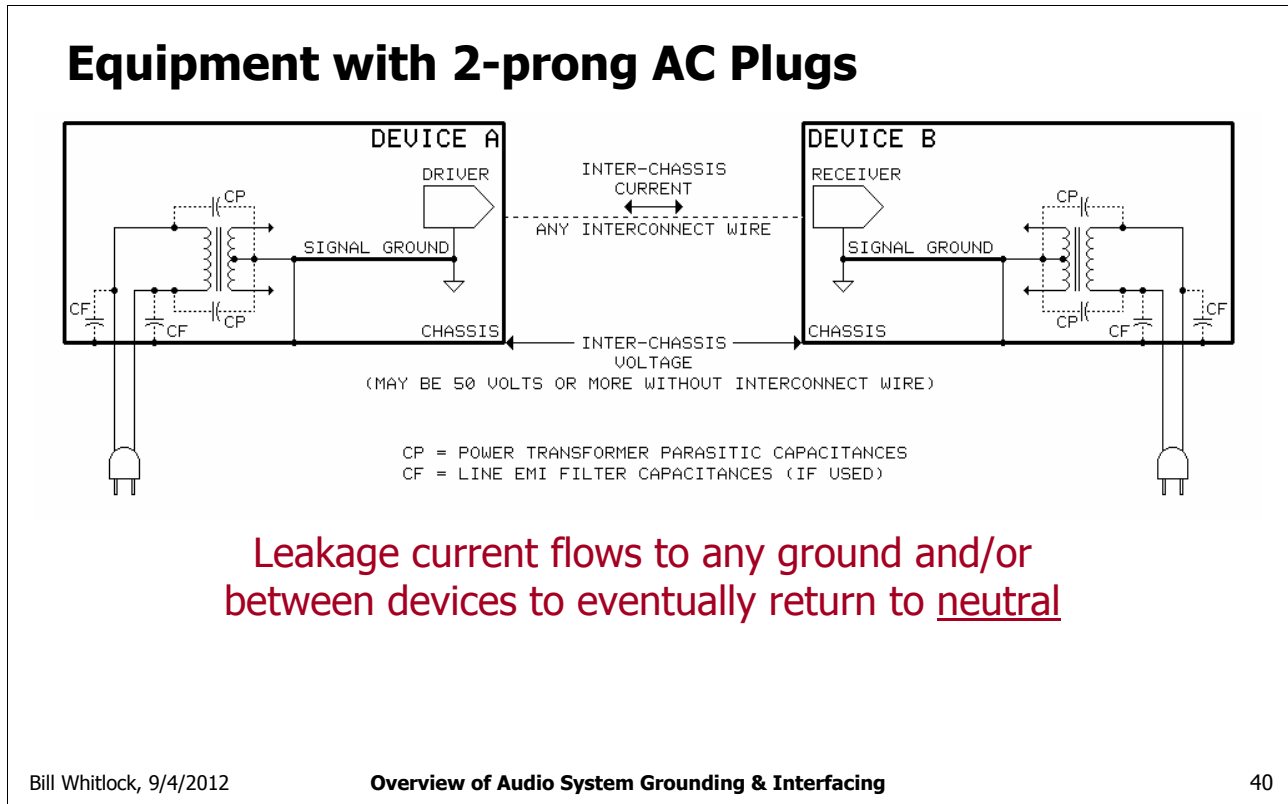

When capacitors have AC voltages impressed across them, they must constantly charge and discharge to the varying voltage. This is the origin of 60 Hz "leakage" current.



## About 2-prong Plugs

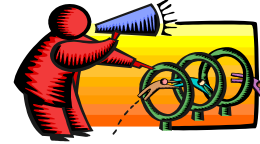

- UL listing demands extraordinary measures:
  - Insulation “creepage” distances must be large
  - One-shot thermal cutoffs must be embedded in transformers and motors that might overheat
  - Equipment must remain safe in spite of component failure, overload, and mechanical abuse
- Chassis voltage with respect to ground may approach 120 V but available current is harmlessly low
  - But it’s enough to drive a high-impedance voltmeter to readings that frighten those who don’t understand!

Even external “wall-wart” transformers must be thermally protected and well insulated to get a UL listing.

## How AC Wiring Affects A/V Systems

- Hum is rarely caused by “improper” grounding
- Properly installed, fully NEC-compliant premises wiring **normally** creates small voltage differences between outlet safety grounds
- Generally, safety ground voltage differences:
  - Are lowest (milli-volts) between nearby outlets on the same branch circuit
  - Are highest (often over 1 volt) between distant outlets on different branch circuits
  - **Over 3 volts indicate a serious wiring error that should be investigated immediately!**

To meet the **NEC guideline of no more than 5% voltage drop (6 volts for a 120-volt circuit) at the farthest outlet on a branch circuit under full load**, the drop per conductor would be 3 volts or less. Therefore, 3 volts is the maximum voltage difference that should ever exist between neutral (N) and safety ground (G) at an outlet. Even if neutral and safety ground are swapped somewhere on the branch circuit, this places an upper limit of 3 volts on the voltage seen between any two safety grounds.

## The Facts of Life



- Voltage differences will **always** exist between grounds of outlets
  - Lowest between nearby outlets on the same branch circuit
  - Highest between distant outlets on different branch circuits
  - **Over 3 volts between any outlets indicates a serious wiring error!**
- Leakage currents will **always** flow in signal cables connected to equipment powered via 2-prong AC plugs
- This occurs in every properly wired, fully Code-compliant premises

Leakage currents are an issue only with unbalanced interconnections. Voltage differences, due almost entirely to the conduit transformer effect, are disaster to unbalanced interconnections and the driving force behind problems in balanced interconnections.

## Ground Loop Links Aggressor and Victim

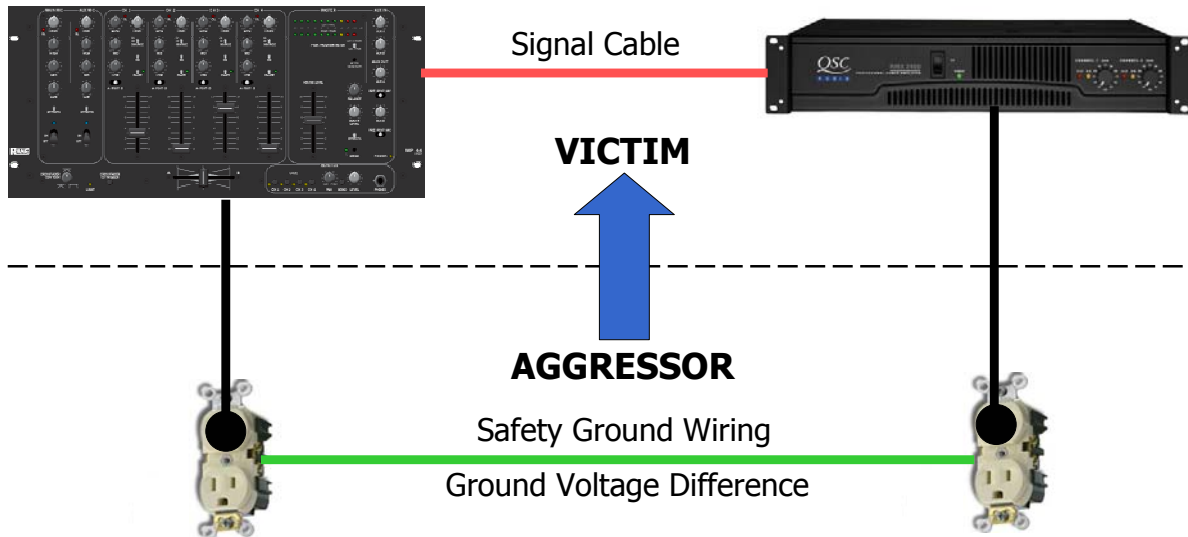

## SIGNAL INTERFACES & NOISE COUPLING

- An **interface** consists of a line **driver** (device output), the **line** or cable itself, and a line **receiver** (device input)
- **Two** conductors are always required to complete a signal circuit
- The purpose of modern interfaces is to transfer signal **voltage**
  - Before amplifiers existed, interfaces like 1900 telephone systems were designed to transfer maximum **power** — but those days are long gone!

## Unbalanced vs Balanced

- Status depends **ONLY** on **IMPEDANCES**, *with respect to ground*, of the two signal conductors!
- In unbalanced interfaces, one impedance is **zero** (grounded) while the other is significantly higher
- In balanced interfaces, impedances are **equal**
  - Since they're all in parallel, this requires that driver, line, and receiver each have equal impedances to ground

**This is, without a doubt, the single most misunderstood concept about interfaces!**

### Unbalanced vs Balanced

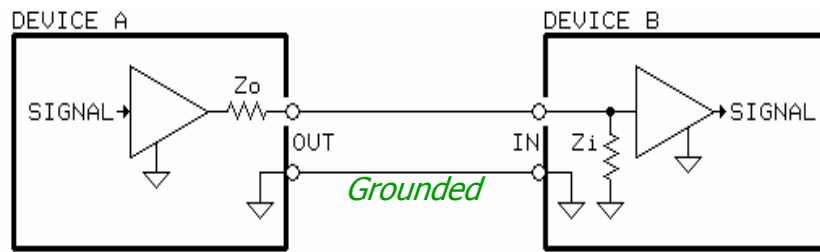

Unbalanced

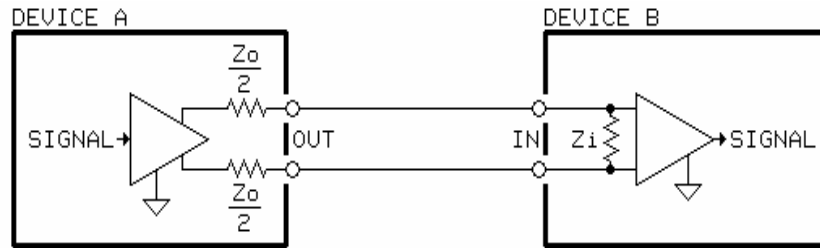

Balanced

## Line Drivers

- Every **driver** has an internal impedance called **output impedance** or “output source impedance,” shown as  $Z_o$
- **$Z_o$**  is often confused with **load impedance**
  - **Load** impedance is external to the equipment and generally consists of cable capacitance in parallel with the input impedance of the receiving input
  - Sadly, manufacturers often omit  $Z_o$  and specify only a minimum load impedance ... which tends to perpetuate the confusion
  - Low  $Z_o$  is desirable but it can't reach  $0 \Omega$  in real-world equipment
- IEC standard 61938 (2010) specifies 
  - $Z_o \leq 2.2 \text{ k}\Omega$  for “general-purpose consumer” outputs
  - $Z_o \leq 1 \text{ k}\Omega$  for “general-purpose professional” outputs
  - $Z_o \leq 50 \Omega$  for “broadcast and similar line amplifier” outputs

**Many, many people confuse “output impedance” with “load impedance” – and manufacturers are no help as they continue to confuse customers by omitting source impedance!**



## Line Receivers

- Every **receiver** has an internal impedance called **input impedance**, shown as  $Z_i$
- High  $Z_i$  is desirable but it can't reach infinity in real-world equipment
- IEC standard 61938 (2010) specifies 
  - $Z_i \geq 22 \text{ k}\Omega$  for "general-purpose consumer" inputs
  - $Z_i \geq 10 \text{ k}\Omega$  for all professional and broadcast line amplifier inputs
- A legacy term, relating to  $600 \Omega$  telephone lines, for high-impedance ( $\geq 10 \text{ k}\Omega$ ) inputs is "bridging" since many of them can be driven simultaneously by a low-impedance ( $\leq 600 \Omega$ ) source

**For balanced inputs,  $Z_i$  is the "differential" input impedance ... i.e., between the two lines with no reference to ground**

## An Interface is a Series Circuit

- Driver  $Z_o$  and receiver  $Z_i$  form a **series circuit** when connected
- Since voltage drop is to impedance in a series circuit, it is often called a **voltage divider**
- Maximum signal voltage across  $Z_i$ , the receiver input, is developed when  **$Z_i$**  is at least 10 times  **$Z_o$**
- Typical audio interfaces transfer 90% to 99.95% of the available signal voltage
  - 50  $\Omega$  to 1 k $\Omega$  is a typical range for  **$Z_o$**
  - 10 k $\Omega$  to 100 k $\Omega$  is typical range for  **$Z_i$**
- Because video interfaces must use terminated true transmission lines, where  $Z_o = Z_i = 75 \Omega$  typically, they transfer 50% of signal voltage

Making input impedances much, much higher than output impedances is sometimes called "**voltage matching**", but I think the term is somewhat misleading.

## Voltage Dividers in Interfaces

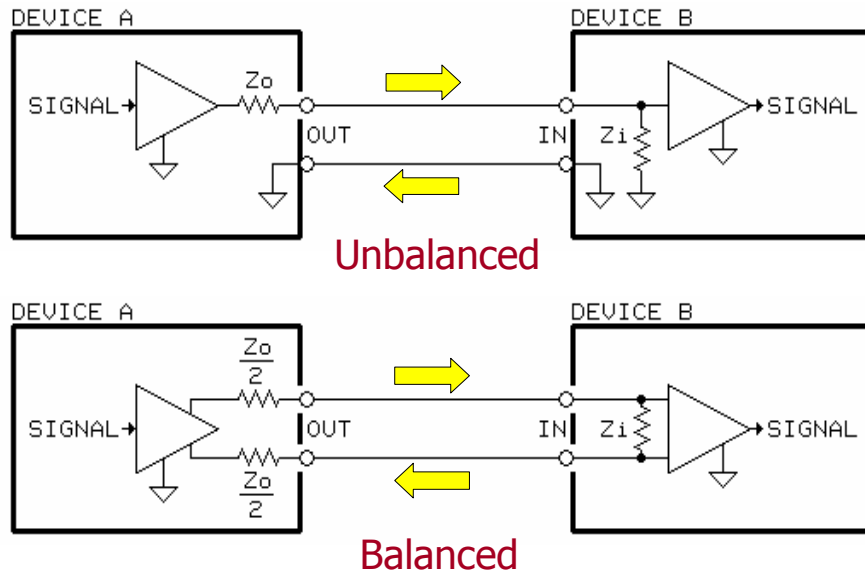

Arrows indicate the signal current path.

## Impedance “Matching”

- It’s a myth that **audio** output and input impedances,  $Z_o$  and  $Z_i$ , should have the same or **matching** values!
  - Apparently based on use of  $600\ \Omega$  “matching” by telephone companies
  - If impedances are matched, maximum **power** is transferred
  - Impedance matching wastes half the signal voltage and forces the line driver to drive an unnecessarily heavy load
- As shown earlier, all modern audio interfaces, including power amplifier to speaker, are designed to transfer **voltage**, not power!
- However, depending on the highest frequency it must pass and its physical length, a cable may behave as a **true transmission line** that does require the same impedance at each end.

As we showed earlier, maximum **voltage** is transferred by using low source impedances and high load (or input) impedances.

## Termination of Transmission Lines

- **Transmission line** effects become significant when the cable's physical length becomes about 10% of an electrical wavelength at the highest signal frequency of interest
  - A **wavelength** is the distance traveled by the signal during one cycle
  - Signals travel in cable at about 70% to 90% of the speed of light
  - **Characteristic impedance** is the impedance of an infinite length of cable
  - Signals will reflect in the cable, causing video ghosts or data errors, unless terminated in its characteristic impedance at each end
- Video, RF, and data cables over a few inches long need terminations
- **For analog audio cables, termination is unnecessary!**
  - 10% of a wavelength at 20 kHz in cable with a propagation velocity of 70% is **3,442 feet** ... if your cable is longer than this, consider terminations

Characteristic impedance of a particular cable depends on its physical dimensions (wire size and spacing) and the insulating material (air, foam, plastic, etc.). Typical coaxial cables come in 50  $\Omega$  and 75  $\Omega$  varieties and typical twisted-pair (CAT-5 for example) cables range from 100  $\Omega$  to 130  $\Omega$ . **Calling a 6-foot audio cable a "transmission line" is bullshit ...**

## Why 600 Ohms?

- First US telephone systems used existing telegraph lines
- Miles long ... they are true audio transmission lines
- Wire size/spacing gives them a **600  $\Omega$**  characteristic impedance
- Became Bell standard for system transformers, filters, etc.
- Equipment "migrated" to early radio and recording systems ...
- Remains "standard" in some communications systems



**The 600  $\Omega$  "standard" does NOT apply to modern audio systems!**

**The term "600  $\Omega$ " is often misappropriated to mean simply "line-level."**

**And old legendary practices fade away very, very slowly!**

## UNBALANCED Audio Interfaces

- **INHERENTLY SUSCEPTIBLE** to noise coupling!
- It's truly ironic that they still dominate consumer audio after 50 years, even though the dynamic range of readily-available program material has steadily increased!



Bill Whitlock, 9/4/2012

Overview of Audio System Grounding & Interfacing

55

When vinyl records and FM radio were the “quality” audio media, 70 dB of dynamic range was enough. But today, any consumer can access CD or digital broadcast media with 100 dB or more dynamic range.

## Irony of the Unbalanced Interface

- "RCA" or "phono" connector appeared about 1948
- Home audio evolved into separate "components" in the 1960s and used ever longer cables to interconnect them
- Unbalanced interfaces remain the norm in consumer gear, home theater, and even in outrageously expensive "audiophile" gear
- **Balanced** interfaces, hallmarks of truly professional systems, avoid the **inherent** noise problem with unbalanced interfaces!

**When talking audio, the words "unbalanced" and "professional" should never appear in the same sentence!** And this author is still trying to figure out exactly what "semi-professional" and "musical-instrument grade" mean!



## The "Good Ol' Days"

- In 1960, most home theater systems were self-contained
  - RCA cables were all internal and very short
  - A single AC cord, with no safety ground, powered it all
- **Life was good!**

NOW STEREOPHONIC HIGH FIDELITY IN TELEVISION TOO... THE ALL-INCLUSIVE

# New Stereo Theatre

MAGNAVOX 24" TELEVISION... FM/AM RADIO... PHONOGRAPH

Now music becomes magic and pictures become alive to bring you the world's greatest entertainment through Magnavox stereophonics. The Stereo Theatre combines all the innovations of electronic science in one beautiful furniture piece—automatic phonograph; FM/AM radio; and big-picture chromatic TV that brings you

the new stereo television programs—all for the price of one! Magnavox offers you a wide variety of styles and price ranges—truly the finest, and your best buy on any basis of comparison. TV prices as low as \$159.90, stereophonic phonographs from \$149.90. See and hear them at Magnavox dealers listed in your yellow pages.



The only all-inclusive stereophonic home entertainment center with... two separate sound channels, six speakers, FM/AM radio, Diamond Stereo Pick-up and precision phonograph. Dimensions: 53" wide, 17" deep, 32" high. In four finishes, mahogany at \$545.00.

THE MAGNIFICENT  
**Magnavox**

The Magnavox Company, Fort Wayne, Indiana: world leader in quality television—stereophonic—high fidelity... and precision electronics for our government and industry.

10

Bill Whitlock, 9/4/2012

Overview of Audio System Grounding &amp; Interfacing

57

I graduated high school in 1962 and spent my last two years working part-time in a TV repair shop (Webb's City in St. Petersburg, FL). I worked on many of these TV, AM-FM radio, and phonograph "combo" units. Invariably, they contained at least two separate chassis inside – interconnected with numerous **very short** RCA cables.

## “Component” Systems Changed Everything ...



Bill Whitlock, 9/4/2012

Overview of Audio System Grounding & Interfacing

58

And consumers were largely “on their own” to solve hum and buzz problems ... **most manufacturers, as today, just pretended the problems didn’t exist and that it’s a fanciful “plug-and-play” world.**

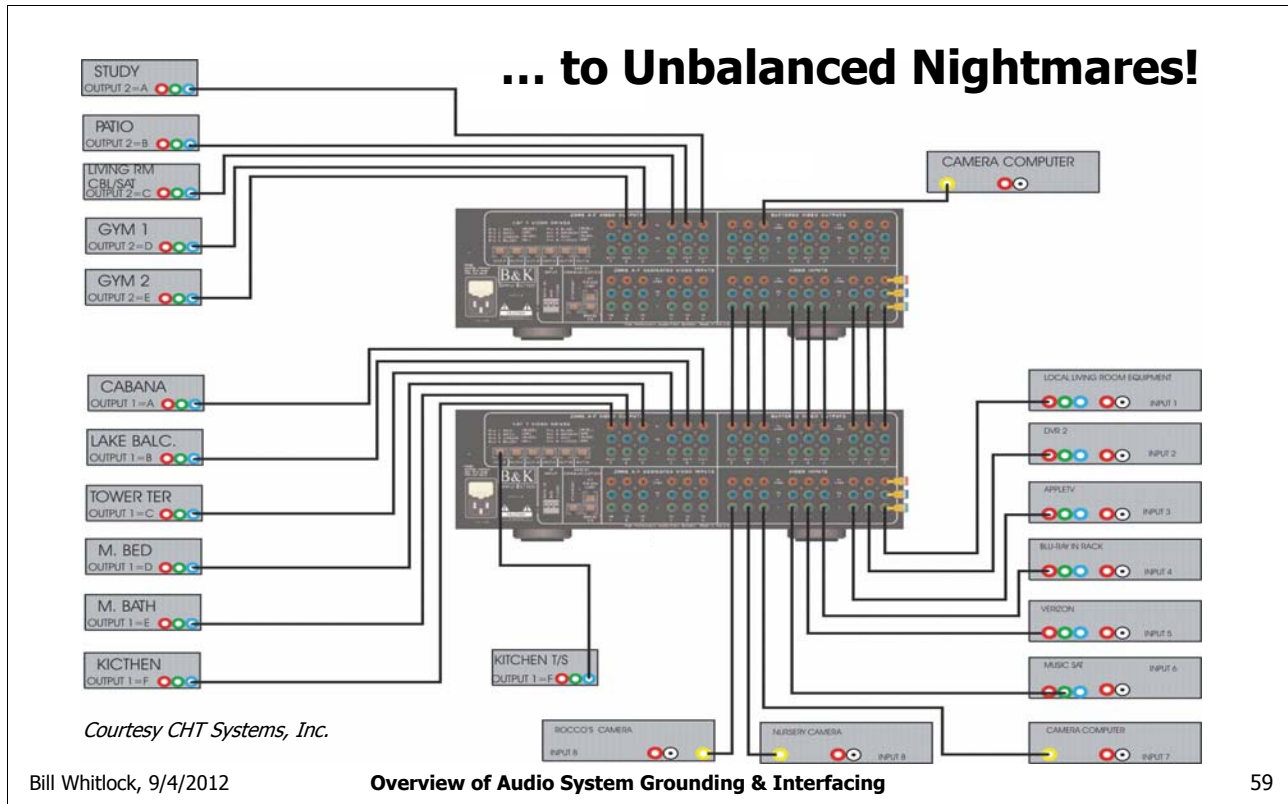

This is just the video portion of a huge AV system in a 10,000 square-foot residence. It's only reasonable to EXPECT ground loop noise issues in any system covering such large physical distances with unbalanced interconnections.

## The **BIG** Problem with Unbalanced

- When two devices, each having its own power cord, are connected by an audio cable, a small power-line current will flow in the audio cable ... a fact of life
  - Essentially all this **current** flows in the grounded conductor, typically the "shield" of audio cables
  - Since this conductor has **resistance**, a noise **voltage** appears over its length ... per Ohm's law
- The **noise** voltage is **directly added to the signal** seen at the receiver ... just like two batteries in series

Maybe if we have room-temperature super-conducting wire someday ...

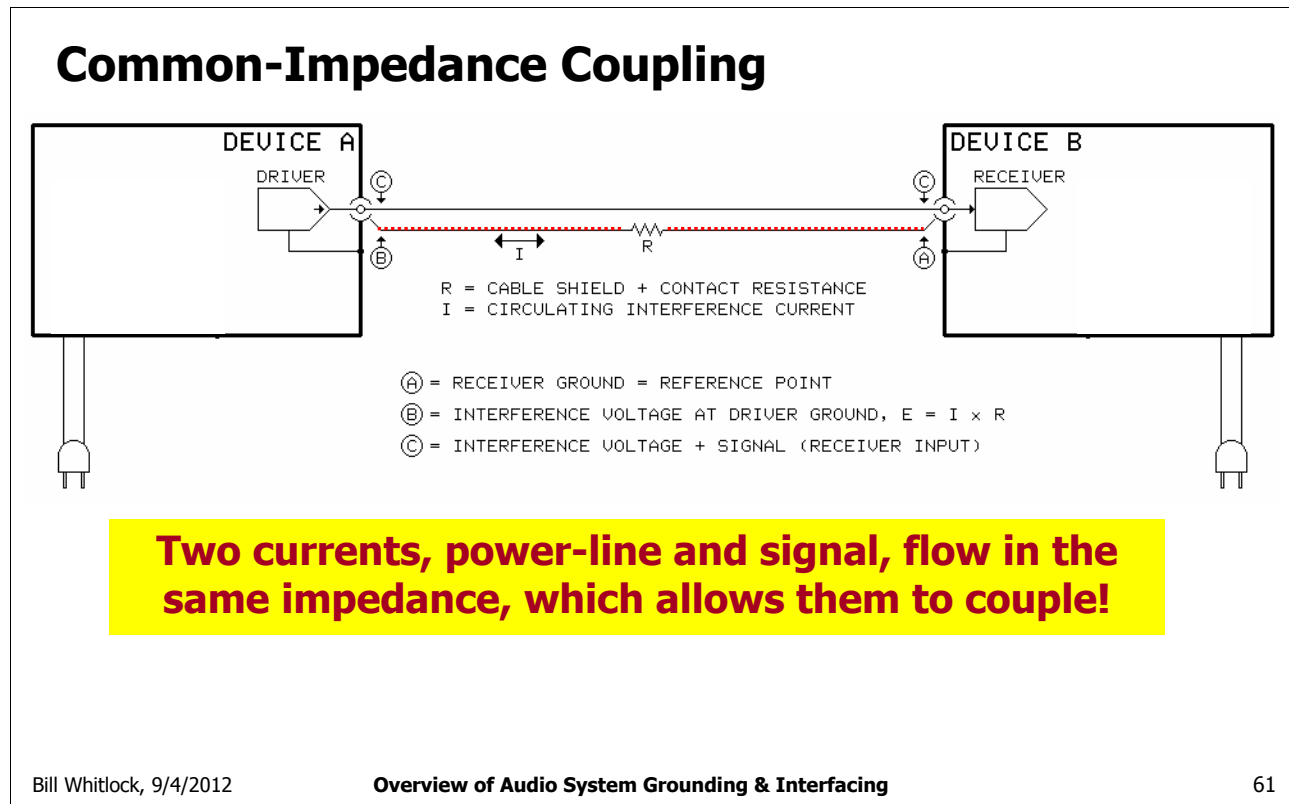

Technically, this coupling mechanism is called “common-impedance coupling” because an impedance (resistance) is “common” (shared) to two circuits. One circuit is between device A output and device B input (the signal circuit) and the other is between the AC power connections at each device. In this example, since there are no safety ground connections, the current in the second circuit is due to “leakage current” (which flows from power-line to chassis in each device). The “common impedance” is, of course, the resistance of the grounded conductor (usually, but not always, the shield) in the interconnect cable.

## Leakage Current Effect

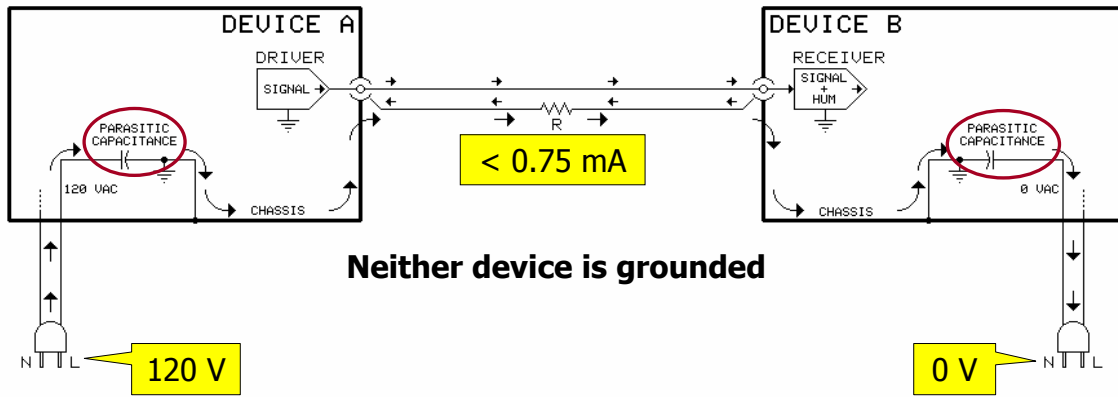

Neither device is grounded

**Generally OK if interconnect cable is under 10 feet long**

The "parasitic capacitance" in each device causes a small AC current to flow. Just as with a battery, current must flow into a capacitor to increase the voltage across it – or "charge" it. Conversely, current must flow out of a capacitor to decrease the voltage across it – or "discharge" it. Since these capacitors connect to the 120 VAC 60 Hz AC power, the voltage across them is constantly changing and a predictable amount of AC current will flow in the process. For equipment with UL listing and a 2-prong AC power connection, this current can be no higher than 0.75 mA – just enough to cause a slight tingling sensation if it flows in your body. Although harmlessly low, this current can cause enough voltage drop over the length of the signal interconnect cable to add significant "buzz" to the audio. While it's remotely possible that leakage current could cause a "hum bar" issue in video, this author has never seen or heard of such a case.

## Leakage Current Effect - A Calculated Example

- A 25-foot cable (foil shield, #26 AWG drain wire) has an end-to-end shield resistance of  $1 \Omega$
- Measured leakage current between the ungrounded devices is  $316 \mu\text{A}$  (well under the UL limit of  $750 \mu\text{A}$ )
- From Ohm's law, noise voltage  $E = I \times R = 316 \mu\text{A} \times 1 \Omega = 316 \mu\text{V}$
- Consumer  $-10 \text{ dBV}$  reference level =  $316 \text{ mV}$
- Signal to Noise ratio =  $20 \times \log (316 \text{ mV}/316 \mu\text{V}) = \mathbf{60 \text{ dB}}$ 
  - **This is 35 dB worse than an audio CD!**
- Same length of **Belden #8241F** cable, with its shield resistance of only  $0.065 \Omega$ , makes S/N  $84 \text{ dB}$ , an **improvement of 24 dB!**

**From a noise perspective, shield resistance is the most important parameter of all. How many times have you seen it specified on a data sheet or in advertising hype? I rest my case about clueless manufacturers!**

## It Gets Far, Far Worse!

- The ugly truth: **unbalanced interfaces simply can't deliver on the "plug-and-play" promise**
  - Only the smallest of systems in the most benign imaginable electrical environments could possibly live up to the promise
  - Turn the volume to maximum and listen closely — all you should hear is hiss
- **If unbalanced interfaces exist between two grounded points in a system, hum and buzz can easily become larger than the signal!**
  - Ground voltage differences between outlets is effectively applied across the ends of the audio cables and directly added to the signal
  - Other "alien" ground connections, such as CATV or DBS, can create comparable voltage differences

**No hum/buzz at all, or hum/buzz that's barely audible in the hiss, should be the goal for a serious listening system.**



## Voltage Difference Effect

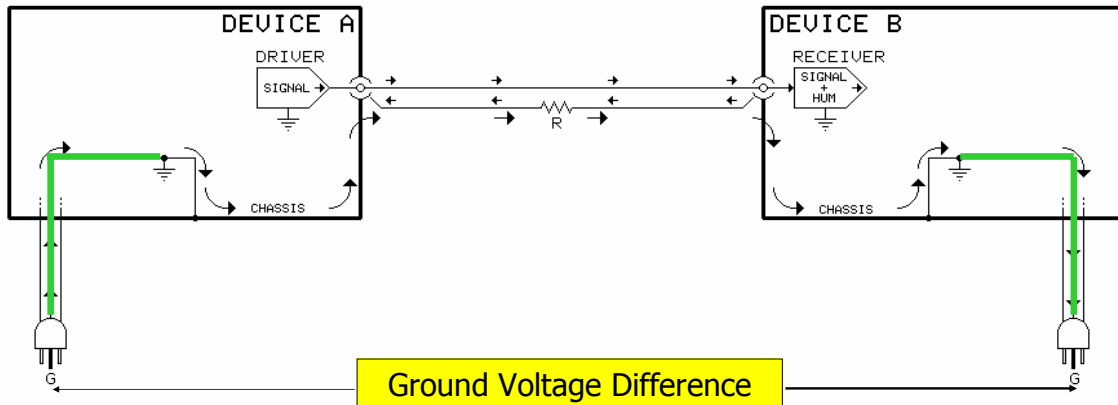

**Even a few millivolts here can be noise disaster!**

Remember in our previous example with ungrounded (2-prong) power cords, the voltage across the cable ends was only 316  $\mu\text{V}$ . **Imagine what a rather common 30 mV of ground voltage difference between outlets would do to S/N ratio!** Actually, the resulting S/N would be only about 20 dB ... unbearable to most listeners. **Even installing a "cheater" (3-to-2 prong adapter) or cutting off a safety ground pin from one of the power cords would still leave as much as 3.5 mA flowing in the interface cable ... that's 10 times the current of the previous 2-prong example, so a serious noise problem would still exist ... as well as a much more serious safety hazard!**

## THE VIDEO HUM BAR

"A dark, horizontal bar in a TV picture caused by hum interference in the (analog) video signal."

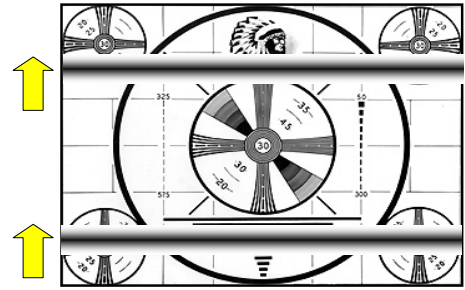

- **In NTSC video, the slow upward movement is the "tell-tale" signature of coupling from 60 Hz AC**
  - Movement caused by the 0.06 Hz frequency difference between the 59.94 Hz NTSC field rate and 60.00 Hz AC power
  - Takes 16 seconds for each of 2 bars to move from bottom to top of screen
  - The **pair** of disturbances (120 Hz rate) occurs because power-line load current induces the voltage in the "conduit transformer" and it has a positive and negative peak in each cycle
- In component color interfaces, the bar is often a distinctive color

The symptoms for digital video interfaces such as DVI or HDMI are completely different.

## Coupling in Video Cables

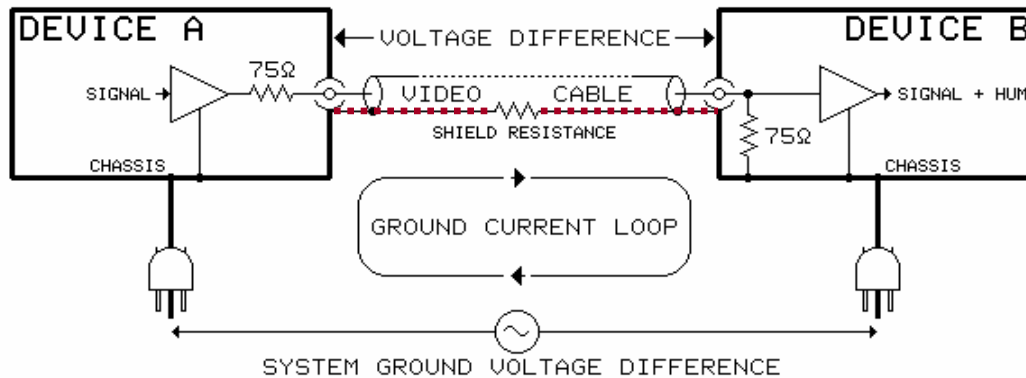

- **Common-impedance coupling – again**
- This time, only half of ground voltage difference adds to signal because of 75 Ω terminations at the driver and receiver

Just as in the unbalanced audio interface, tiny voltage drops appear over the length of the cable's shield. This voltage adds itself to the signal seen at the receive end of the cable.

## What's Visible

- Standard analog video signal is 1 V peak-to-peak
- About 700 mV produces visible black to white range
- About 7 mV peak-to-peak hum bar interference is visible under worst-case conditions
  - Equals **14 mV peak-to-peak across cable ends**
- "Pedestal clamping," a technique used in some video input circuits, can increase tolerance to hum bars

Pedestal clamping is also sometimes called "DC Restoration".

## The BALANCED Interface

- Inherently immune to noise coupling – that’s why professionals use it!
- Telephone companies popularized it and use it to this day
- **But its true nature is widely misunderstood:**

“Each conductor is always equal in voltage but opposite in polarity to the other. The circuit that receives this signal in the mixer is called a differential amplifier and this opposing polarity of the conductors is essential for its operation.”

This **WRONG** explanation, like many others in print, **doesn’t even mention the defining property of a balanced interface!**

**This misconception has led to lots of bad equipment design ... and to the old IEC test method**

## It's All About Impedance!



“Only the common-mode **impedance balance** of the driver, line, and receiver play a role in noise or interference rejection. This noise or interference rejection property is **independent** of the presence of a desired differential signal. Therefore, it can make no difference whether the desired signal exists entirely on one line, as a greater voltage on one line than the other, or as equal voltages on both of them. **Symmetry** of the desired signal has advantages, but they concern headroom and crosstalk, not noise or interference rejection.”

*IEC Standard 60268-3 (2000)*

**I finally convinced them ... now they “get it”**

## An Accurate Definition

"A balanced circuit is a two-conductor circuit in which both conductors and all circuits connected to them have the **same impedance with respect to ground** and to all other conductors. The purpose of balancing is to make the noise pickup equal in both conductors, in which case it will be a common-mode signal which can be made to cancel out in the load." *Henry W. Ott, Distinguished Member of the Technical Staff, AT&T Bell Labs*

**Henry Ott and Ralph Morrison are two physicists whose work I truly admire!**

## Balanced Interface Circuit

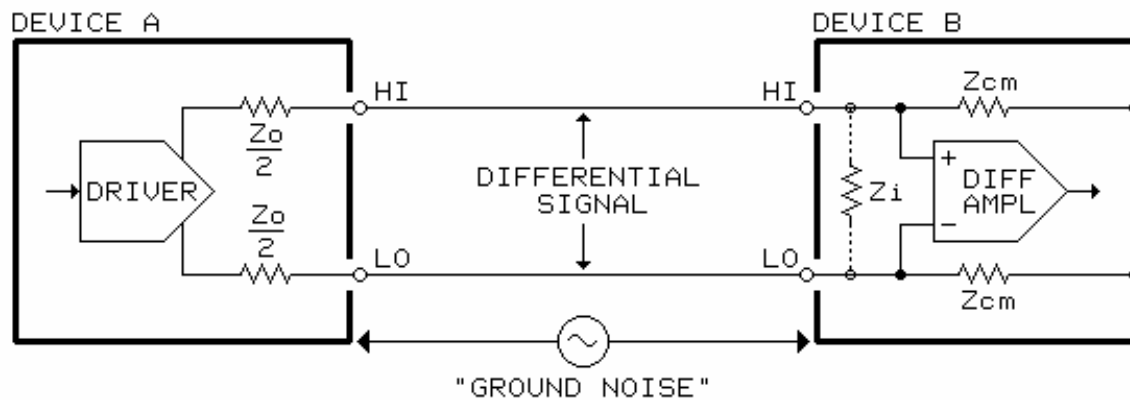

The desired signal is "differential-mode" or **DM**  
 Ground noise and interference creates "**common-mode**" or **CM**

Drivers can have different topologies, but this one, where the outputs are virtually grounded by the driver, is the most common ... and easiest to understand.



## About Common-Mode

- A voltage that appears identically on both lines or input terminals is called **Common-Mode** or **CM** voltage
- Three main sources of common-mode voltage:
  - Voltage difference between driver and receiver grounds
  - Voltage induced in cable by a magnetic field
  - Voltage induced in cable by an electric field
- A balanced line receiver can reject **any** interference that results in **identical** voltages at its two inputs
  - **"Identical"**  $\pm 0.1\%$  = 60 dB rejection,  $\pm 0.01\%$  = 80 dB rejection, etc.

Extreme matching is required to achieve useful noise rejection.

## Common-Mode Rejection Ratio or CMRR

- **Ideal** receiver would respond only to differential voltage – with no response whatsoever to common-mode voltage
- **Real** receiver is either an “active” circuit or a transformer
  - Limited common-mode rejection
  - The **ratio** of **DM** (signal) gain to **CM** (noise) gain is called **Common-Mode Rejection Ratio**, or **CMRR**
    - Commonly expressed in **dB**
    - **Not** a measure of signal **level** – it’s wrong to express it as dBu, dBV, or dBm!
    - Is a **positive number** (not negative) for any useful receiver
- Higher CMRR figures mean better noise rejection

**CMRR is the most useful, and widely used, measure of noise rejection in a balanced interface.**

## A Balanced Interface is a Wheatstone Bridge

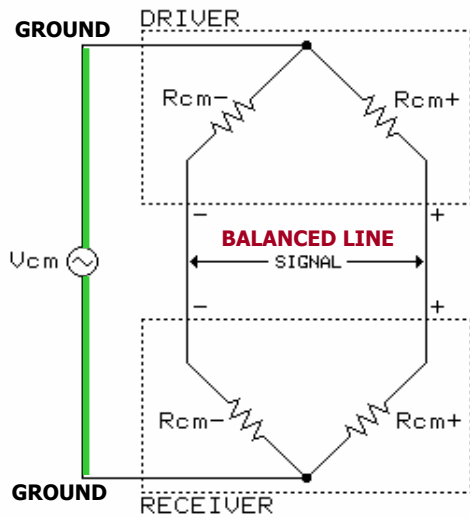

- CM impedances form the bridge
- If not precisely “nulled,” the bridge **converts** ground noise  $V_{cm}$  to signal
- A “null” requires precise ratio match of the + and – voltage divider arms
  - Most sensitive to component tolerances when all arms have the same impedance
  - Least sensitive when upper and lower arms have widely differing impedances – the wider the better!
- Although low driver and high receiver CM impedances are the norm, the  **$Z_{cm}$  of most receivers is not nearly high enough!**

**A Wheatstone bridge uses a generator and a detector. The resistance in one of the arms is adjusted for a “null” in the detector. In the case of the balanced interface, the “generator” is the ground voltage difference and the “detector” is the balanced line receiver itself.**

## “Reality” vs “Advertised” CMRR Specs

- Zcm tolerance of **real-world** drivers typically determined by  $\pm 5\%$  series resistors and  $\pm 20\%$  (or worse) coupling capacitors
  - Typical Zcm **imbalances** are about  **$\pm 10 \Omega$  at 60 Hz**
  - Typical **real-world** “active balanced” line receivers have Zcm ranging from 10 k $\Omega$  to 50 k $\Omega$
- This low receiver Zcm makes **real-world INTERFACE CMRR** exquisitely sensitive to normal driver Zcm imbalances!
  - CMRR of the popular SSM-2141 suffers a **25 dB drop** with only a **1  $\Omega$  imbalance** in driver Zcm
- **Noise rejection or CMRR of an interface may be much less than the CMRR number advertised for the line receiver, depending on exactly what equipment is driving it!**

In fact, most electrolytic capacitors have even looser tolerances, commonly +80%, -20%. To make matters worse, they also change capacitance with age! However, the larger their capacitance, the less imbalancing effect their tolerance and aging will have.

## Bad Tests Lead to Bogus “Specs”

- **Only a complete interface can have CMRR** because the driver, cable, and receiver critically interact!
- Traditional CMRR tests completely ignore “real-world” signal source impedance imbalances that can drastically reduce CMRR
  - **Most commonly, the receiver inputs are shorted together, simulating a “bogus” source with zero impedance and zero imbalance**
  - Similarly, the former IEC test source had real impedance but it was “tweaked” for **zero imbalance** – to laboratory perfection!
- Real-world signal sources tested had impedance imbalances ranging from 0.3  $\Omega$  to 30  $\Omega$ , so my new test specifies a **10  $\Omega$  imbalance**
  - My new real-world test method was adopted and published August 2000 in *IEC Standard 60268-3, Sound System Equipment - Part 3: Amplifiers*

**In 1999, the IEC issued a call for comments about the existing CMRR test. They recognized that its results had little correlation with results in real-world audio systems ... duh!**



# Tests for CMRR – Old vs New

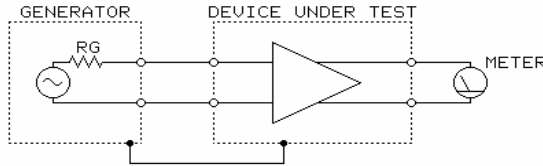

IEC Normal-Mode Test

Establishes 0 dB reference for common-mode gain

## Old – Tweaked Until Perfect

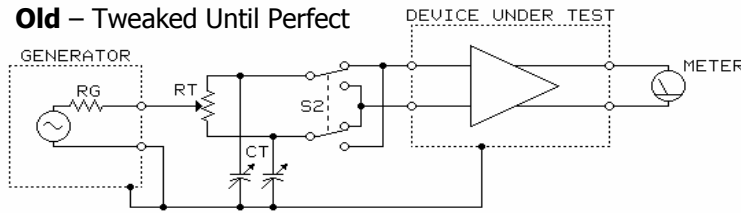

IEC Common-Mode Test 1988 Ed 2

RT and CT are trimmed for same reading as S2 is toggled. This "perfect" reading is used to calculate CMRR.

## New – Imbalanced $\pm 10 \Omega$

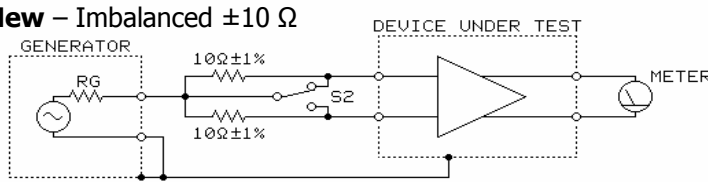

IEC Common-Mode Test 2000 Ed 3

S2 is toggled and highest reading noted. This reading is used to calculate CMRR.

**The old test used a very clever method make sure the source impedances to the two DUT inputs were perfectly matched. Unfortunately, this perfection was its undoing!**

## Audio Precision Model APx525

**First Commercial Analyzer to Incorporate the New IEC Test**



## How Much CMRR is Enough?

- Professional reference signal level is +4 dBu = 1.23 V
- A "hostile" 1.23 V ground voltage difference (common-mode voltage) might exist in a system
- In this case only, SNR (signal-to-noise ratio) = **Interface CMRR**
- Total dynamic range = SNR + "headroom"
- If headroom is 15 dB, CMRR of 80 dB would result in 95 dB of total dynamic range, which is comparable to an audio CD
  - A "less hostile" 123 mV ground voltage difference would increase dynamic range by 20 dB
- **80 dB of "real-world" CMRR is generally acceptable, but 50 dB is rarely enough for a commercial sound system**

**According to my esteemed colleague Neil Muncy, "50 dB is NOT enough CMRR" in most systems.**



## The “Pin 1 Problem” – A Designed-In Defect

- Common-impedance coupling that occurs inside equipment, turning their shield connections into very-low-impedance signal inputs!
- Dubbed the “pin 1 problem” (XLR pin 1 = shield) by Neil Muncy in his 1994 AES paper
- This defect has been inadvertently designed into an alarming number of products ... and, sadly, it continues
- **It allows shield current (power-line noise) to flow in wires or PCB traces shared by internal amplifier circuitry**
- **This problem can exist at I/O ports, whether analog or digital, in any piece of equipment**

Neil Muncy’s comprehensive paper about this was published in the June 1995 AES Journal. Since wires and PCB traces have small but significant resistances, the current flow is converted to small voltages that couple into the signal path ... adding noise to the output signal.

## Good Designs Avoid "Pin 1 Problem"

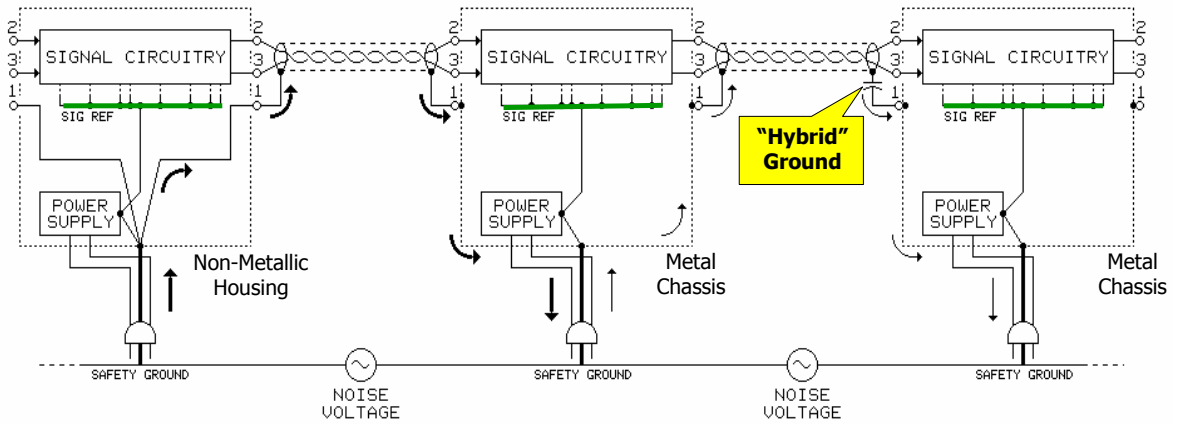

**Shield currents "want" to flow back to safety ground – giving them a separate, direct route avoids the problem!**

**Hybrid grounding** is a technique that allows the shield to effectively be grounded at high frequencies (RF) but prevents problems associated with low-frequency (60 Hz and audio) current flow in shields. This topic will be mentioned later ...

**CAUTION, "Pin 1 Problem" Inside!**

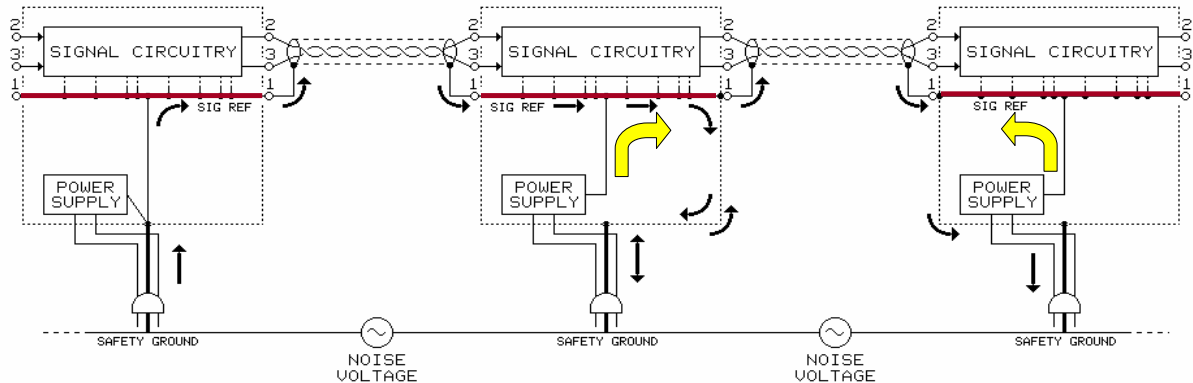

Shield current flows in signal reference "ground" inside equipment

Power-line noise, coupled by the power supply, flows in signal reference ground in two of the boxes. This design error produces so-called "sensitive" equipment!

The tiny voltage drops created along the "SIG REF" conductors are amplified by the circuitry, resulting in noise at the output. **So-called "sensitive" equipment contains a related design error that causes power line noise (coupled through the power supply) to flow through signal reference ground on its way to safety ground (to return to its source). I think a more appropriate name for such equipment is "power-line primadonna".**

## CABLE ISSUES

- "A cable is a source of potential trouble connecting two other sources of potential trouble."
- Electric Field Shielding
  - Provided by copper braid or aluminum foil
  - Resistance critical for unbalanced
  - Construction critical for balanced
- Capacitance
  - Can reduce audio bandwidth in long runs
- Magnetic Field Shielding
  - Provided by coaxial construction for unbalanced
  - Provided by twisting of inner signal pair for balanced
  - Copper and aluminum have no effect on LF magnetic fields



**Strange that cable manufacturers still don't "get it" ... they seem to think "floobydust" is more important.**

## Electric Field Shielding

- Electric fields exist when **voltage** between two points is high
- Capacitance  $C_c$  is formed by air space between conductors
- AC voltage causes AC current flow through  $C_c$
- Current flows in signal line without shield, creating a noise voltage
- Grounded shields **divert noise current** harmlessly to ground
- Without shielding, noise current may couple **unequally** to the two signal conductors of a balanced interface (creating noise signal)
  - **Twisting** improves match by **averaging** physical distances to the field
- Braided shields with  $\geq 85\%$  coverage are usually entirely adequate
- An issue with high I/O impedances in vintage vacuum-tube gear but trivial in modern systems
  - Some "audiophile" cables have no shielding at all — wires are woven

Capacitance exists between any two conductive objects, whether intentional or not. Closer physical spacing and increased surface area both increase capacitance.

## Electric Field Coupling and Shielding

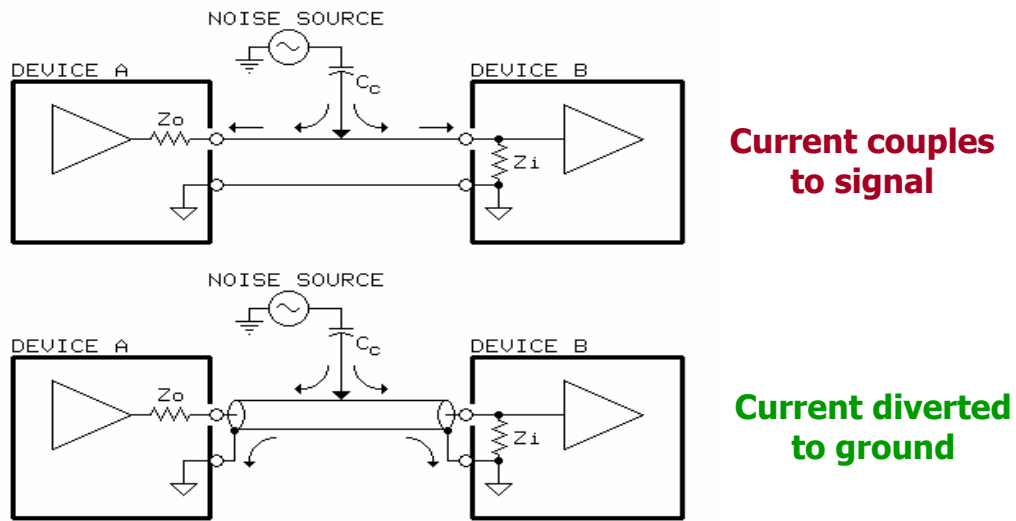

Current couples to signal

Current diverted to ground

Shielding is a diversionary tactic, which stops coupling to one conductor by enclosing it in another.

### Balanced Lines – Ground at Driver or Receiver?

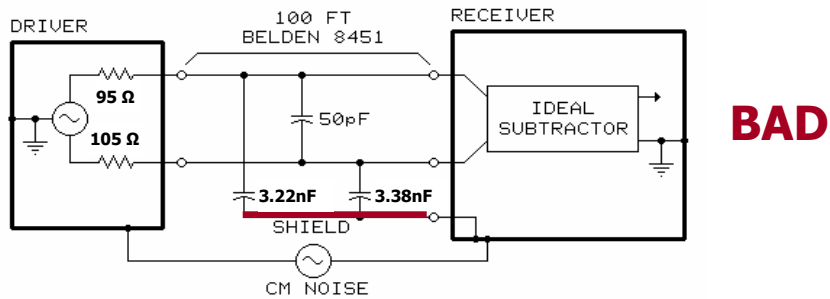

**BAD**

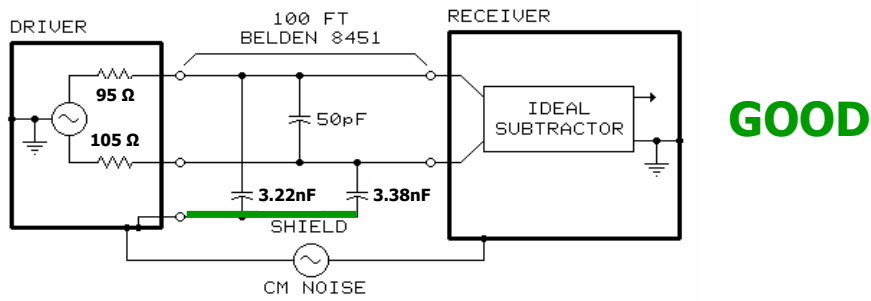

**GOOD**

Unless you're familiar with filters, this may not make much sense to you ...

## “Good” vs “Bad” Balanced Shield Connections

- Commercial cables have capacitances from each signal conductor to shield are typically mismatched by 4% to 6%
  - It's because the two wires have different colors ... honest!
  - Common-mode output impedances of drivers can also have 5% mismatch
- A shield grounded *only* at the **receiver** forms pair of low-pass filters for common-mode noise ... bad
  - The two mis-tracking filters will **convert** a portion of common-mode (noise) to differential-mode (signal), degrading CMRR at high audio frequencies
- A shield grounded *only* at the **driver** eliminates both filters ... good!
  - Because all filter elements move together at the driver ground voltage

Wires of different colors must be made on different machines – the machines that extrude the liquid insulation onto the wire as it is pulled through a die. Die diameter has a tolerance on the order of 0.001”, according to Belden. Therefore, two wires of different color but otherwise identical, can have insulation thickness differences. Calculations of capacitance, using the dielectric constant of the PVC insulation, generally confirm capacitance differences (to the shield) in the vicinity of 5%.



## Shield Connections and Crosstalk

- Driver signal asymmetry and cable capacitance mismatch cause **signal** current flow in the shield at high audio frequencies
  - Shields grounded *only* at the **receiver** force this audio current to return to the driver via an **undefined path** – often resulting in crosstalk, distortion, or oscillation problems as it flows in sensitive circuitry!
  - Shields grounded *only* at the **driver** allows this audio current to return **directly** to where it came from – the line driver and avoid problems
- **Always ground the driver end** of a balanced cable, whether or not the receiver end is grounded
- It's OK to ground both ends – experience has proven it but, for the ultimate attainable interface CMRR, ground only at the driver end

I remember a prototype console checkout at Quad-Eight (when I worked there around 1973) where the internal wiring grounded shields only at the receive end. As the fader was pushed up, with no signal input, suddenly the output VU meters slammed into the pegs. The entire signal chain was breaking into oscillation at 300 kHz!

## Immunity to Magnetic Fields

- Unbalanced cables of coaxial construction are essentially immune to AC magnetic coupling
  - Centerlines of the two conductors are coincident, so there is no "loop area"
- Balanced cables may have mismatched voltages induced into the two signal conductors, the difference becoming noise added to the signal
  - **TWISTING** improves matching by averaging physical distances of each wire to the external field source (just as with **electric** fields)
- Effective **magnetic** shielding for 60 Hz fields requires enclosing conductors in steel conduit or special magnetic alloys
- The most effective prevention comes from
  - increasing the distance between magnetic offender and victim
  - avoiding open loops in the two signal conductors

**Remember that mated XLR barrels and "punch-down block" open up twisting, thus creating vulnerable "loops" for magnetic field pickup. Of course, this is especially important for mic-level cabling.**

## Magnetic Fields from Power Cords

Current in L and N are equal but of opposite polarity

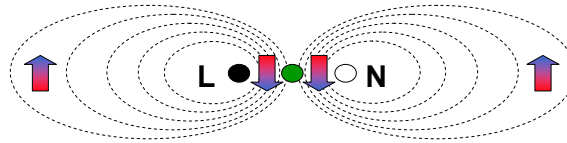

Strong magnetic fields exist only very near the conductors

*(cross-section view)*

***Instantaneous L and N currents are  
flowing into and out of this page***

For power cords of normal construction, either twisted (round) or parallel (flat), magnetic field cancellation is near-perfect unless you get very close to it.

## Magnetic Fields from Power Cords

Far from cord, magnetic field cancellation is nearly complete

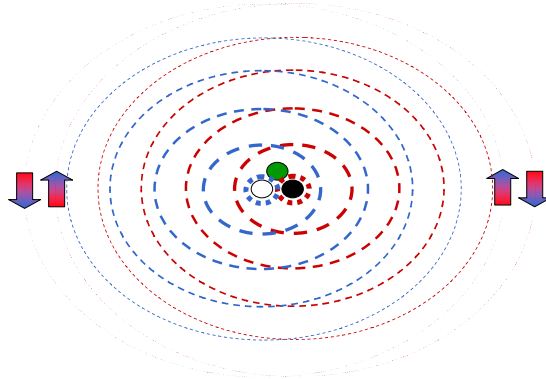

At distance of 10 times the conductor spacing, magnetic field is about 1% of close-in value

**At a distance of 2" or 3", magnetic fields from power cords are negligibly weak.**

## Nullifying Magnetic Coupling

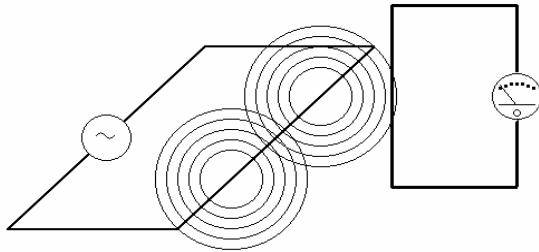

Wires **exactly** 90° to each other have zero coupling

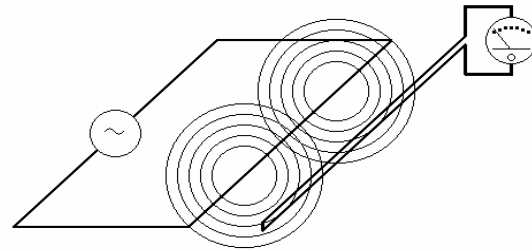

In a "hairpin loop," equal **induced** voltages series oppose and cancel ... twisting further improves

It's the physics of magnetic fields ... we'll see later that this principle is used in the "dummy tests" to determine if magnetic fields are inducing noise into a signal cable (we short one end of the cable as shown with the "hairpin loop" and listen to the voltage at the other end).

## Shield Current Induced Noise (SCIN)

- Current flow in cable shield creates a magnetic field **extremely** close to the twisted pair inside
- Physical imperfections in real cables result in **unequal** induced voltages, which adds the difference to the signal
  - Dubbed **SCIN** in 1994 AES paper by Neil Muncy
  - Best cables use braided or counter-wrapped spiral shields to create a very uniform magnetic field around the twisted-pair
  - **WORST** cables use a **DRAIN WIRE**, which “hogs” the shield current and distorts the magnetic field (whether it has a braid or foil shield)
- For low-level signals, cables with drain wire should either be avoided or connected so that no current flows in the shield (i.e., grounded at one end only)

**Pronounced “S” “C” “I” “N”, not “skin.”** The “skin-effect” is quite different and we won’t discuss in this class. In addition to Neil’s original paper, Jim Brown and I have also written AES papers on the subject.

## “Hybrid” Shield Grounding

- Resolves the audio frequency vs RF conflicts about shield grounding for balanced audio cables
- At audio frequencies, grounding shields only at the driver produces the best possible interface CMRR
- But, at radio frequencies, grounding shields at the receiver often reduces or eliminates RF interference
- “Hybrid” grounding uses a capacitor to ground the receiver end of the cable at RF frequencies only
  - AES Standard on Interconnections, AES48, issued in 2005 (after years of agonizing debate) includes this method
  - The capacitor must be constructed and connected in a way that makes it effective up to at least 1 GHz ... and that’s not trivial!

**The hybrid grounding technique generally uses a capacitor value in the 10 nF to 100 nF (that’s 0.01  $\mu$ F to 0.1  $\mu$ F) range. To be effective at high frequencies (over a few MHz), the capacitor leads must be extremely short!**

## The Neutrik EMC Connector

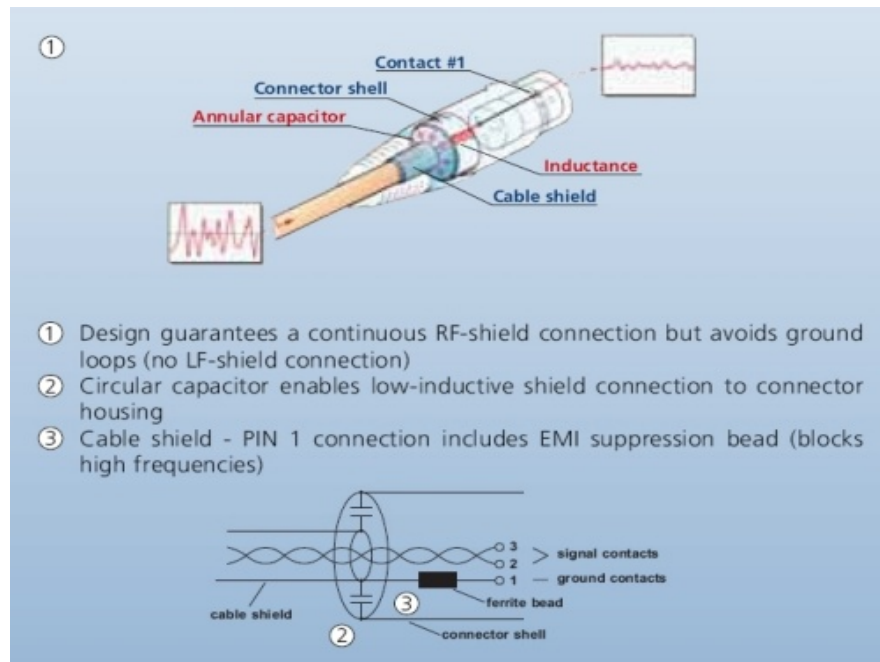

Bill Whitlock, 9/4/2012

Overview of Audio System Grounding &amp; Interfacing

96

**The first commercial connector to embrace the “hybrid” grounding idea.** The ferrite bead functions to impede the ingress of RF to the inside of a shielded equipment enclosure, while the capacitor ring passes RF currents to the **outside** of the equipment enclosure. The capacitive pathway remains low-impedance to frequencies as high as 1 GHz. Thank you Neutrik!



## High Capacitance Cables

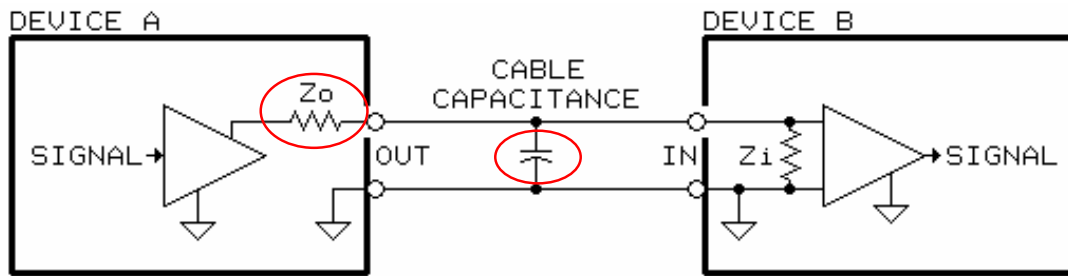

- Some "exotic" audiophile cables have very high capacitance
- Cable C and driver  $Z_o$  form a low-pass filter
- For typical consumer  $Z_o = 1 \text{ k}\Omega$  and  $C_c = 50 \text{ pF/ft}$ 
  - 20 kHz response down 0.5 dB @ 50', 1.5 dB @ 100', and 4 dB @ 200'

It can sure take the "sizzle" out of the top end ...

## High-Frequency Cable Behavior

**Over 40 kHz, shielded cables themselves eliminate ground noise!**

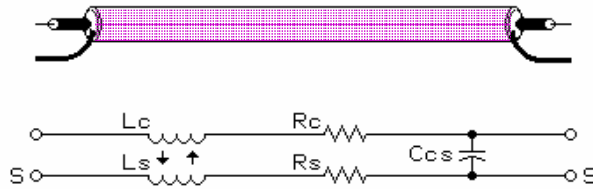

- At audio frequencies,  $R_s$  is responsible for common-Z coupling
- Impedance of shield rises above 4 kHz (typical) due to  $L_s$
- At 10 times this frequency, essentially all voltage across  $L_s$  is **magnetically induced** into  $L_c$ , canceling receiver common-mode noise
  - Voltage in  $L_c$  subtracts S to S (common-mode) voltage from signal
- **Shielded cables inherently cancel CM noise above  $\approx 40$  kHz**
  - Weigh this against claims made for power-line filters ...
  - This **does NOT apply to UTP** cables such as CAT-5 types

Power-line filters in “conditioners” only begin to work at frequencies over about 40 kHz ... but these frequencies do not cause either common-impedance coupling in unbalanced cables or common-mode voltages at balanced inputs, provided that cables with normal coaxial shielding is used in either case. Power-line filtering, unless the filter starts working at a few hundred Hz (which would make it the size of a refrigerator), are useless in the reduction of hum and buzz ... duh! **Those who choose UTP over STP, especially in audio and video work, should consider what they’re giving up in terms of noise rejection in the interface!**

## *Physics from Another Universe? The Emperor's New Audio Cables?*

- Double-blind tests prove that when audible differences among cables actually do exist, they're entirely explainable
- Marketing hype often invokes transmission line theory and implies that nano-second response is somehow important
- Real physics reminds us that audio cables only begin to exhibit subtle transmission line effects when some **3,500 feet** long



**"High-end" audio is awash in pseudo-science, anti-science, and mysticism.**

**Tom Nousaine** has published excellent information about ABX "double-blind" testing and some very interesting results. See [www.nousaine.com](http://www.nousaine.com).

### Physics from Another Universe?

- Exotic cables, even if double shielded, made of 100% pure un-obtainium, and hand woven by virgins, will have no significant effect on hum and buzz!
- Truly high-performance unbalanced audio cables combine **very low shield resistance**, low capacitance, and reliable connectors
- I like Belden 8241F (even if they call it video cable)
  - It combines very low shield resistance, low capacitance, high flexibility, and availability in lots of pretty colors!



Make your own "designer cables" that actually do something worthwhile!

## **TROUBLESHOOTING**

Without **method**, it can be both frustrating and time-consuming!



Bill Whitlock, 9/4/2012

Overview of Audio System Grounding & Interfacing

101

**The silent scream "says" it all ...**

## “Think” ... Like a Detective

- **DON'T start by changing things!**
- Ask questions: “Did it ever work right?”
- **Equipment controls** can provide valuable clues
  - Volume Control – if turned down, does noise disappear or remain unchanged?
  - Source Selector – do all sources have the noise or just one?
- Keep written notes, memory is less reliable
- Problems that go away by themselves are also very likely to unexpectedly reappear by themselves ...
- “Gentlemen, let the finger-pointing begin!”



**Effects of equipment controls are extremely valuable but nearly always overlooked** – I know “firsthand” from experience in helping thousands of customers troubleshoot audio systems! For example, if a hum disappears when the volume is turned down, logically it must be entering the signal path before the volume control. Conversely, if it is unaffected by the volume control, logically it must be entering the signal path after the volume control. Similarly, source selector switches can identify which source is affected or if all are affected. These are very important clues when troubleshooting!

## Draw a “One-Liner”

- Show **ALL** signal cables and indicate their approximate length
  - **ANY** cable can be a **pathway** for a ground loop!
  - Show data and control cables, even though not part of the signal path
- Mark any balanced inputs or outputs
- Show stereo pairs, **RGB**, etc. as single lines
- Note all equipment grounded by its 3-prong AC power plug
- Note any other ground connections such as CATV feeds, DBS dish feeds, or rack mounting

Jensen offers free help with troubleshooting but sometimes a caller whines about the documentation I ask for. I've been known to ask them **“If you can't take the trouble to sketch up the system, why should I take the trouble to try to figure it out with so little information?”** Once I have the sketch and know what the symptoms are, I most often ask them to perform a couple of simple tests (like *temporarily* lifting a ground with a 3-to-2 prong adapter or unplugging that USB cable to a PC) and then tell them where and what the problem most likely is ... and sometimes they end up not needing to buy anything from us, which is OK with me. I believe they'll remember where they got real help, not hype, the next time they need assistance.

### A Sample "One-Liner"

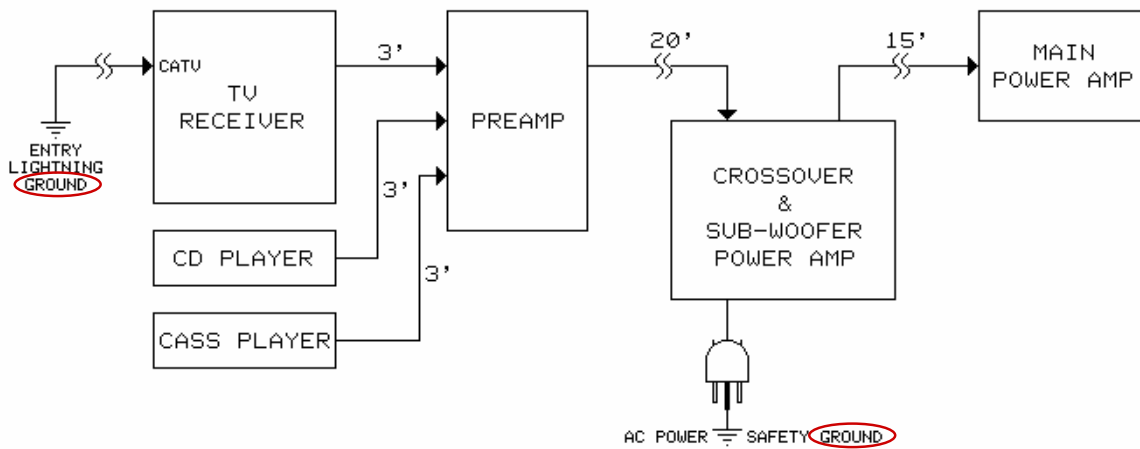

Bill Whitlock, 9/4/2012

Overview of Audio System Grounding & Interfacing

104

All equipment is assumed to have 2-prong (ungrounded) AC power unless noted otherwise. It's not necessary to show speakers unless they're the powered type (amplifier built-in).



## Work Backwards!

- Unless clues suggest otherwise, always begin at audio power amplifier or video monitor inputs and test interfaces in sequence back toward signal sources
- **REMOVE “ground lift” devices before troubleshooting!**
  - These illegal “cheats” generally disguise the real problem
  - Although having a 3-prong power cord and 3-prong outlets, some “audiophile” power strips internally disconnect the safety ground!
  - Look for a UL label on **every** AC power component in the system.



## Testing: Unbalanced Audio Interfaces

- The “Dummy Test” can locate the exact noise coupling point
- It also reveals the exact nature of the problem
  - **Common-impedance coupling in cables** – by far, the most “common”
  - Common-impedance coupling inside equipment – the “pin 1 problem” design defect often exists at unbalanced interfaces, too
  - Magnetic or electric field pickup by cables

**The “dummies” are not people, they’re devices!**

## The Unbalanced Audio "Dummy"



For Audio RCA

P1 = Switchcraft 3502 Plug

J1 = Switchcraft 3503 Jack

R = 1 k $\Omega$ , 5%, 1/4 W Resistor

For Audio 2C Phone

Use Switchcraft 336A and 345A  
Adapters with RCA version



**ISO-MAX® Model TA-R1 "Dummy"**

**Remember, the "dummy" DOES NOT pass signal!**

**Jensen offers a pair of TA-R1 dummy adapters (as pictured) along with a printed troubleshooting guide for \$10.**

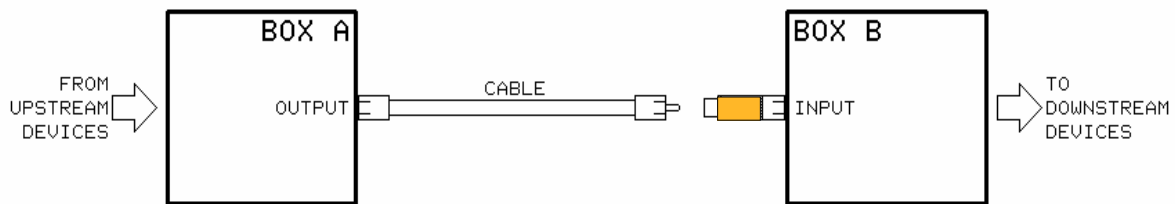
**STEP 1**

Unplug the existing cable from Box B and replace with dummy

- **Noise** — problem is internal to Box B (or downstream)
- **Quiet** — go to step 2

If clues don't suggest otherwise, Box B would be the power amplifier that drives the speakers and we'd test the first line-level interface as shown in the following steps.

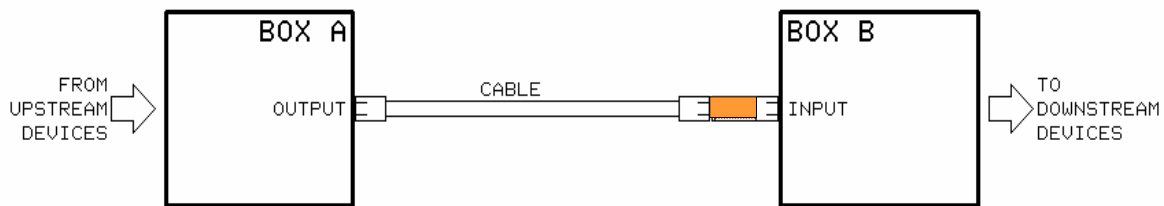
**STEP 2**

Leave the dummy in Box B and plug the existing cable into the dummy

- **Noise** — Box B has a “pin 1 problem.” Confirm with the “hummer” test
- **Quiet** — go to step 3

**The “hummer” test is described later in this section,** right after we cover balanced interfaces.

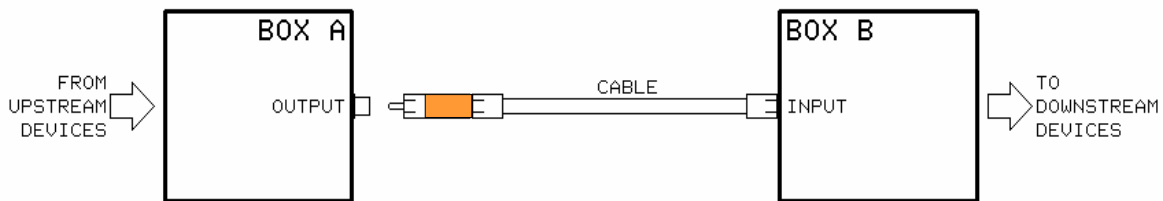
**STEP 3**

Remove the dummy and plug the existing cable back into Box B. Unplug other end of existing cable from Box A and plug it into the dummy. *The dummy must not touch anything conductive!*

- **Noise** — a magnetic or electric field is inducing noise into the cable. Check shield continuity or re-route the cable to avoid the field.
- **Quiet** — go to step 4

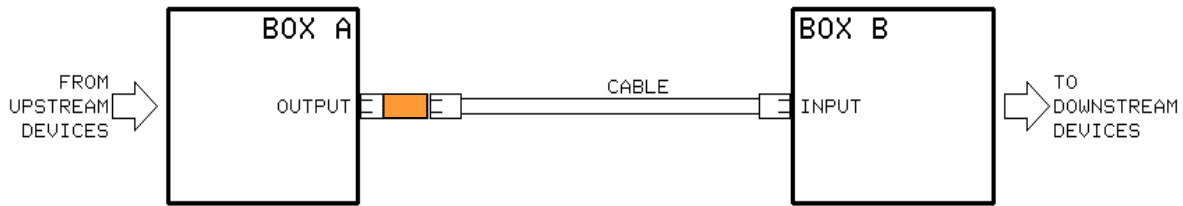
**STEP 4**

Leaving the dummy on the existing cable, plug the dummy into Box A.

- **Noise** — common-impedance coupling in the cable. Install an isolator!
- **Quiet** — noise must be coming from output of Box A. **Perform the 4-step test sequence on next upstream interface.**

**In some cases, replacing the cable with another having much lower shield resistance may provide enough noise reduction to be acceptable.**

## Testing: Analog Video Interfaces

- Because video monitors typically revert to a “blue screen” when the signal is absent, video doesn’t lend itself to “dummy” testing
- Instead, a sensitive clamp-on ammeter is used to identify the route of the ground loop and measure the loop current
- For every video cable that’s part of the loop, either a measured or estimated shield resistance is used to calculate noise coupling voltage according to Ohm’s law,  $E = I \times R$
- Hum bars become visible when the coupling voltage reaches or exceeds a threshold of about 5 mV rms (roughly 15 mV peak-to-peak)
  - A cable with end-to-end shield resistance of  $0.5 \Omega$  is found to have 20 mA rms flowing in it, making the coupling voltage  $20 \text{ mA} \times 0.5 \Omega = 10 \text{ mV}$
  - A component video RGB bundle has 50 mA flowing in it and the paralleled shield resistance is  $0.5 \Omega$ , making the coupling voltage 25 mV



## Clamp-On Ammeter Locates Ground Loops

- Senses current magnetically
- Currents that flow bi-directionally in the cable (like signal currents) are ignored and produce no reading
- Currents that flow in one direction and return elsewhere (like ground loop currents) are measured

High-sensitivity models most often called "Leakage Current Meters"

**A reading resolution of 1 mA or better is highly recommended**



**The AEMC 565 sells for about \$270 (it's a versatile multimeter, too).** Signal currents are ignored because they flow in opposite directions (center conductor and shield) in the video cable, making their magnetic fields cancel. Ground loop current passes one-way only through the cable and is therefore detectable because of the magnetic field it creates around the cable. It can be clamped around signal cables as well as power cords to identify the route and magnitude of ground loops. This method applies to audio, video, data, and signal lines of all kinds ... even laboratory instruments.

## Current vs Cable Type and Length

Cable Type	Diameter	50'	20'	10'
RG-11	0.285"	80 mA	200 mA	400 mA
RG-59	0.242"	35 mA	90 mA	180 mA
Precision	0.233"	26 mA	65 mA	130 mA
Miniature	0.125"	17 mA	43 mA	86 mA
Sub-Miniature	0.097"	9 mA	22 mA	43 mA

Current listed typically produces a barely visible hum bar based on threshold coupling voltage drop of 15 mV peak-to-peak

**In general, the smaller the diameter of the cable, the higher the resistance of its shield conductor – which makes it more likely to become a hum-bar problem. Why is the industry so obsessed with tiny cables anyway?**

## Testing: Balanced Audio Interfaces

- Same basic concept as unbalanced “dummy” tests
- Again, tests pinpoint location of problem interfaces
- **Coupling mechanisms are different:**
  - Shield-current-induced-noise or SCIN in cables
  - Magnetic or electric field coupling in cables
  - “Pin 1 problems” in poorly-designed equipment
  - Inadequate Common-Mode Rejection in equipment inputs

**Unfortunately, this test will not find Pin 1 problems at equipment outputs.**

## Building a Balanced Audio "Dummy"

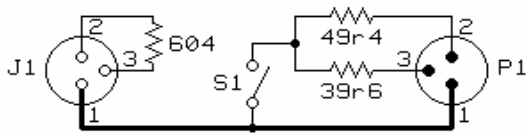

For Balanced Audio XLR

P1/J1 = Switchcraft S3FM adapter  
with QG3F and QG3M inserts  
All resistors 1%, 1/4 W metal film

Close S1 for CMRR Test ONLY

For Balanced Audio 3C Phone

Use Switchcraft 383A and 387A  
adapters with XLR version



Prototype made with housing, connectors and switch of a CalRad #35-465 in-line mic switch

Closing S1 creates the 10 Ω imbalance for IEC-like CMRR test

**Remember, this device DOES NOT pass signal!**

**SHORTCUT: Modify a commercial "microphone kill switch" that normally uses the switch to short pins 2 and 3.**

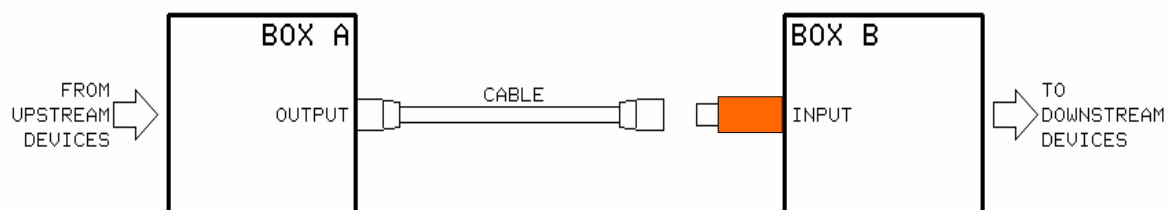
**STEP 1**

Unplug existing cable from input of Box B and plug in just the dummy.  
(switch remains in "NORM" position until Step 5)

- **Noise** — internal problem with Box B (or downstream).
- **Quiet** — go to step 2.

## STEP 2

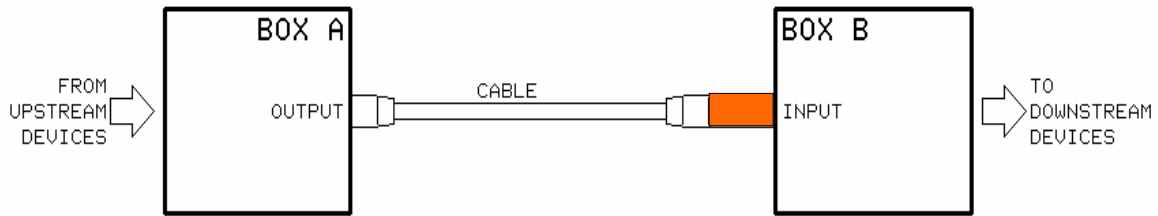

Leave the dummy at input of Box B and plug existing cable into dummy.

- **Noise** — Box B has a **“pin 1 problem”** ... confirm with the Hummer Test.
- **Quiet** — go to step 3

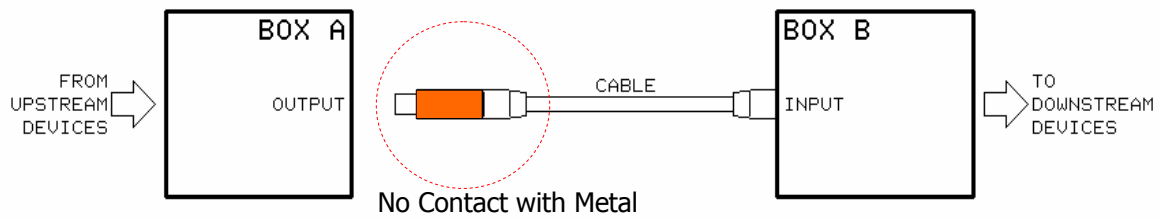
**STEP 3**

Remove dummy and plug existing cable back into Box B. Unplug cable from Box A and plug into dummy.

- **Noise** — magnetic or electric field induction in cable. Check shield continuity or re-route cable to avoid the field.
- **Quiet** — go to step 4.

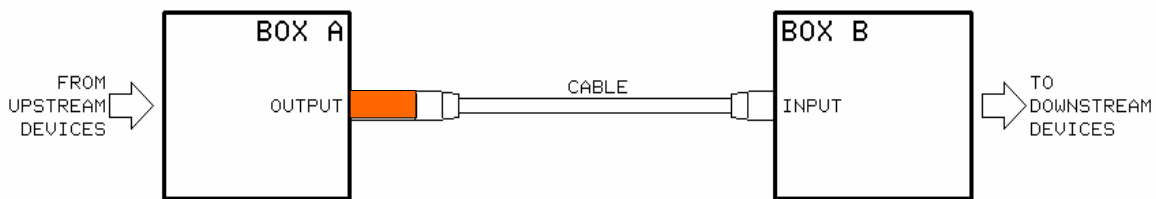
**STEP 4**

Leaving the dummy on the cable, plug the dummy into Box A.

- **Noise — Shield Current Induced Noise or SCIN.** Replace cable or take steps to reduce shield current, possibly lifting shield at receive end.
- **Quiet** — Go to step 5.

“Replace cable” would mean replacing a cable that uses a **drain wire** shield connection with a cable that does not.

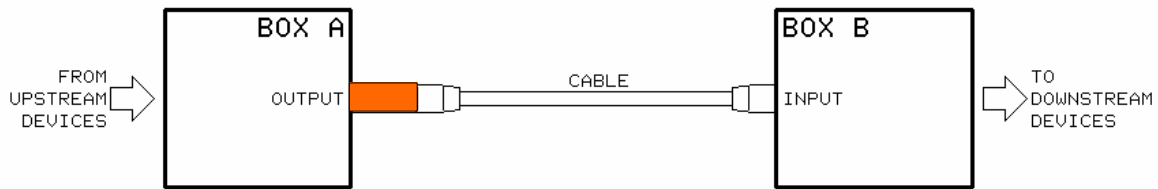

**STEP 5**

With same setup, move the dummy switch from "NORM" to "CMRR."

- **Noise — Poor input CMRR at Box B.** Replace Box B or add an input transformer isolator to increase CMRR.
- **Quiet** — Noise must be coming from output of Box A. Use the "Hummer Test" to determine if Box A has a "pin 1 problem" at its **output**. If not, perform this 5-step test sequence on the next upstream interface.

This CMRR test is a simplified version of the IEC test that uses the existing system common-mode voltage rather than a signal generator. In some ways that makes it a real-world "in-situ" test.

## "Pin 1" Testing with the "Hummer"

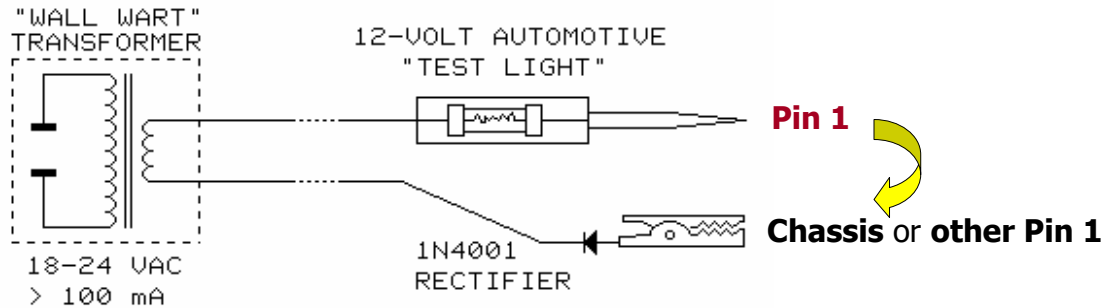

80 mA to 100 mA of Rectified 60 Hz Flows in Suspect Shield Connections

Concept by John Windt, June 1995 AES Journal

This can be easily made by modifying a standard "automotive test light", adding the transformer and diode. **The diode is used to add harmonic content to the 60 Hz current, making it easier to hear. Thus far, I have not created a simple test to reveal the "sensitive" equipment or "power-line primadonna" syndrome.**

## Using the “Hummer”

- Monitor one output and disconnect all other I/O cables
- For reference, listen to output without the hummer connected
- Connect clip to metal chassis and touch the probe to shield contact of each I/O connector
  - If no metal chassis, connect clip to shield of another I/O connector
- A “clean” design will have no output buzz or change in noise floor
- Other test paths include safety ground to I/O shields and input shields to output shields
  - Safety ground is accessible at the AC outlet and testing the path from there to chassis could reveal a problem due to a poorly chosen internal connection

# DON'T BET YOUR LIFE!

- **NEVER** defeat safety grounding to solve a noise problem!
- Adapter is intended to **provide** a safety ground when a 3-prong plug must be used with a 2-prong receptacle
- Outlet cover-plate screw provides connection to safety ground via outlet saddle and metallic box/conduit
- You'll be held legally liable if someone is shocked or electrocuted because you installed a "cheater" ... the judge simply won't care about the buzz it cured!



**OR EVEN WORSE**



This is not only illegal and dangerous, but it may get you sued right out of business. It can, and does, happen. Especially devious are those who clip off the safety ground prong so that nothing seems to be wrong to a casual observer!

## With Utter Disregard for Safety!



**"One of the coolest new innovations ... PS engineers invented a better way: a screw-in ground pin. Instead of using a cheezy cheater plug and ruining all the benefits of the xStream's machined connectors, you simply unscrew the ground pin and voila! No more buzz."**

*www.psaudio.com*

A supreme example of commerce without conscience!

## And Downright Dangerous Advice!

"The safety benefit of having even one component earthed extends to all the other components in the system because they are all connected together by the interconnects. So if one component faults, the **dangerous currents would travel through the interconnects** to the earthed component, and drain safely away through its AC cord." and "But the cheaters are hardly a high-end solution. Some audiophiles deal with this by **cutting the third prong off the plug so they can plug it straight into the outlet without needing a cheater**. That's what I do."  
*from [www.altavistaudio.com/hum.html](http://www.altavistaudio.com/hum.html) May 2012*

**Can you imagine a typical RCA cable carrying a 150 A fault current for the several seconds it might take to trip the AC power circuit breaker?**

**This is just one example of bad advice that's rampant on the internet ...** audiophiles are particularly vulnerable victims. The **150 A** fault current, with a corresponding breaker trip time of about **2.5 seconds**, comes from a UL study of over 1,000 typical residences.

## Consider Signal Cables



- They will distribute **lethal** voltage from a failed but “ground-lifted” piece of equipment throughout an entire system, or
- Fault current may find its way to safety ground through a **signal** cable, causing it to melt or burst into flames!
- **DEFEATING SAFETY GROUNDING IS PROHIBITED BY CODE**
  - **NEC 2008 Articles 250.6(D) and 250.114 specifically prohibit removal of safety grounding for plug-and-cord-connected equipment to solve “noise” issues**
- Signal cables are **NOT** safety ground wiring!

A judge in the liability trial won't give a rat's ass how your “trick” cleared up the hum problem! Even if the customer lives, he can claim he can't sleep or his sex life is ruined since he got that nasty shock ... he'll sue and win!

## The DANGER is REAL

- Typical Year in USA
  - **10 ELECTROCUTED**
  - **2,000 FIRES** causing
    - **20 DEAD**
    - **100 INJURED**
    - **\$30 M property lost**



Bill Whitlock, 9/4/2012

Overview of Audio System Grounding & Interfacing

128

Note the "AC-DC" album in his hand! This is a commissioned cartoon.



## Shock and Electrocution

- Dry skin has high resistance – little current flows
- Increased moisture, contact area, and pressure result in more current
- **Current** determines the severity of shock
  - Under 1 mA is simply an unpleasant “tingling”
  - About 10 mA causes involuntary muscle contraction, the “death grip,” or suffocation if through chest
  - 50 to 100 mA through the chest may induce ventricular fibrillation, causing subsequent brain death
- **ALWAYS HAVE A VERY HEALTHY RESPECT FOR ELECTRICITY!**
- **To help prevent lethal chest currents, always keep the “other” hand in your back pocket!**

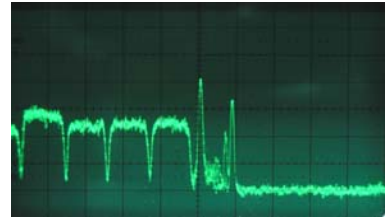

Statistically, high voltages are less dangerous than 120 volts. The slightest contact with high voltages causes severe muscle contractions that usually throw the victim clear of the danger. He'll suffer skin burns where he made contact, but he'll likely live to tell about it. At 120 volts, many victims are found dead but still gripping the energized devices or contacts that killed them. Note that UL leakage current limits are less than 5 mA in any circumstance, well below the involuntary muscle contraction threshold.

## **SOLUTIONS – Breaking the Loop**

- **NEVER defeat safety grounding!**
- Ground loops may include many cables and pieces of equipment
- In general, problems become worse with distance
  - Coupling is worse in longer signal cables
  - Ground voltage differences in safety ground are proportional to length
- Ground isolators in signal path are preferred solution
  - Determining correct location is critically important
  - Sometimes we have more than one location that works
  - Ungrounded equipment can pose a problem for isolators

In many large systems, placement of a single (or single pair) of isolators in the signal path solves a myriad of noise issues related to a single ground loop. The key, as in real estate, is location, location, location!

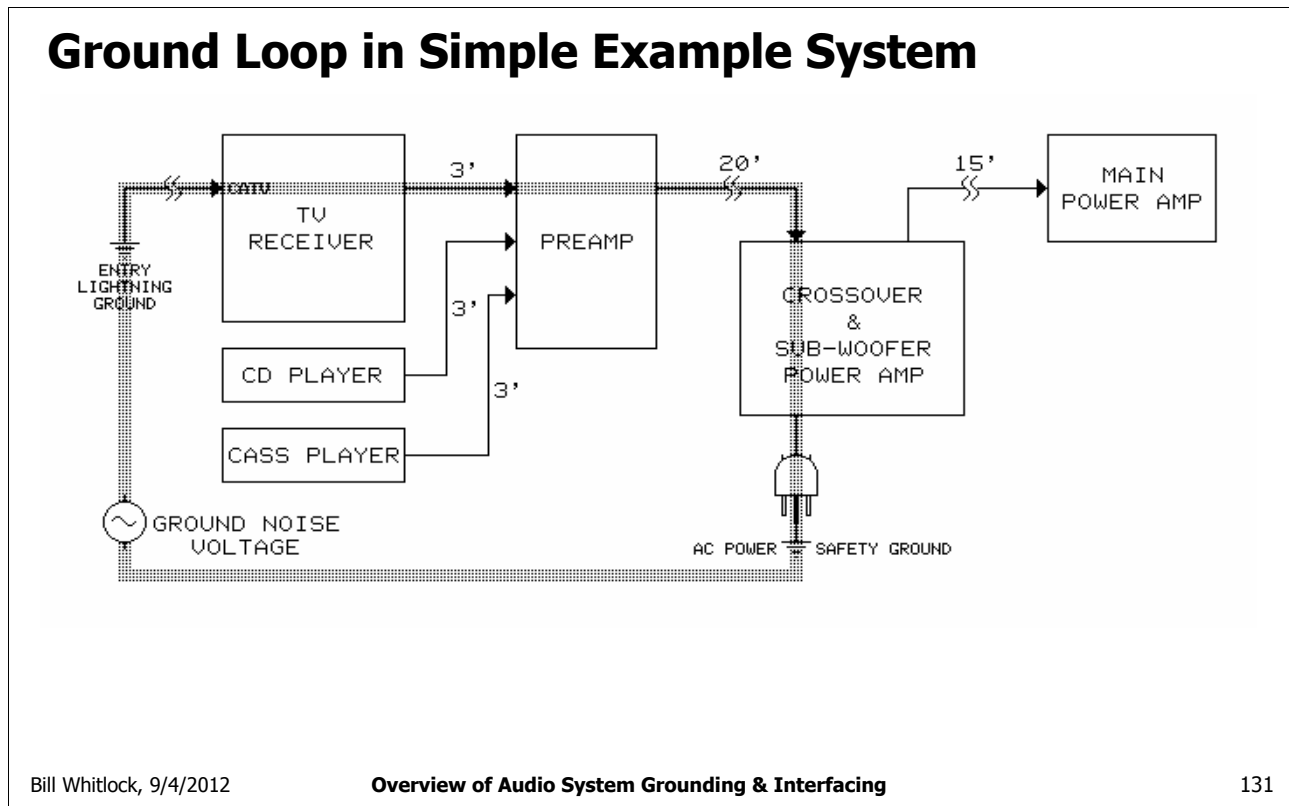

The two different ground points create a ground loop

## ISOLATORS for Unbalanced Audio

- Ground isolators solve **the** inherent problem in unbalanced interfaces
  - An isolator is a differential-responding device with high common-mode rejection (*discussed later in balanced interfaces*)
  - Simply put, an isolator stops noise current flow in the cable shield
- **An isolator is NOT A FILTER**
  - Filters are devices that pass certain frequencies while rejecting others
  - If a filter could be “taught” what spectral “footprint” to remove for every conceivable hum or buzz, it could be inserted anywhere in the signal path!
- To eliminate noise, an isolator must be installed at the interface where the noise coupling actually occurs ...
- **Location, Location, Location ...**

Such filters have been attempted in the digital domain. While moderately successful at removing a steady hum, they don't do well with more harmonically complex buzz. It's essentially impossible to pass high-quality music through such a filter without altering the sound in a very audible way.

## Two Basic Types of Audio Transformers

- An ideal transformer would completely stop ground loop current ... at all frequencies
- In reality, capacitance between windings allows some current to flow “around” the transformer at high audio frequencies
- Two basic types differ greatly in capacitance:
  - **OUTPUT** types have **HIGH capacitance**
    - Typically **10,000 pF or more**
    - **Noise reduction about 40 dB worse than input type**
    - The only type made by nearly all Jensen competitors ...
  - **INPUT** types have **VERY LOW capacitance**
    - Typically **100 pF** (1% of output type) due to internal Faraday shielding
    - Large capacitive load on output will reduce HF bandwidth
    - Use long cable on input side, **keep output cable under 3 feet**

Jensen makes both types of transformers, and each is well-suited for a particular application. **Output transformers are simply a poor choice if maximum noise reduction is the goal.**

## Isolators: “Friends with Benefits”

- Benefits of **INPUT** type transformers
  - Noise rejection over 80 dB, whether the signal source is balanced or unbalanced
  - Filter out ultra-sonic and RF interference, reducing “spectral contamination”
  - Solve “Pin 1 problems”
  - No power required
  - Simple, passive, robust, reliable, and virtually immune to transient surges

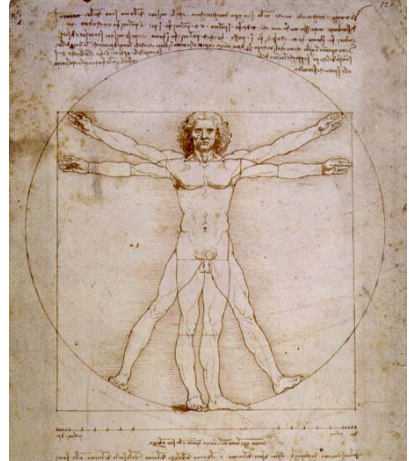

**“Simplicity is the ultimate sophistication”**

**Transformers have no concept of “ground” – they “don’t care” whether a signal source is balanced or unbalanced.**

## Transformer Isolators for Unbalanced Audio

“Isolation is under-appreciated but astoundingly useful.”

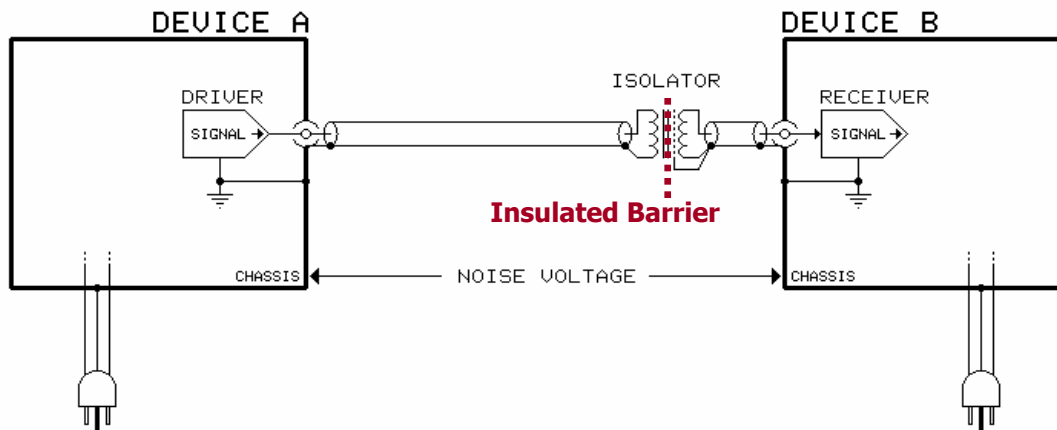

The electrical path between the boxes via the signal cable is broken and the signal is magnetically coupled across an insulated barrier

The insulated barrier inside the transformer, which can easily withstand several hundred volts, makes it impossible for ground loop current to flow through the audio cables.

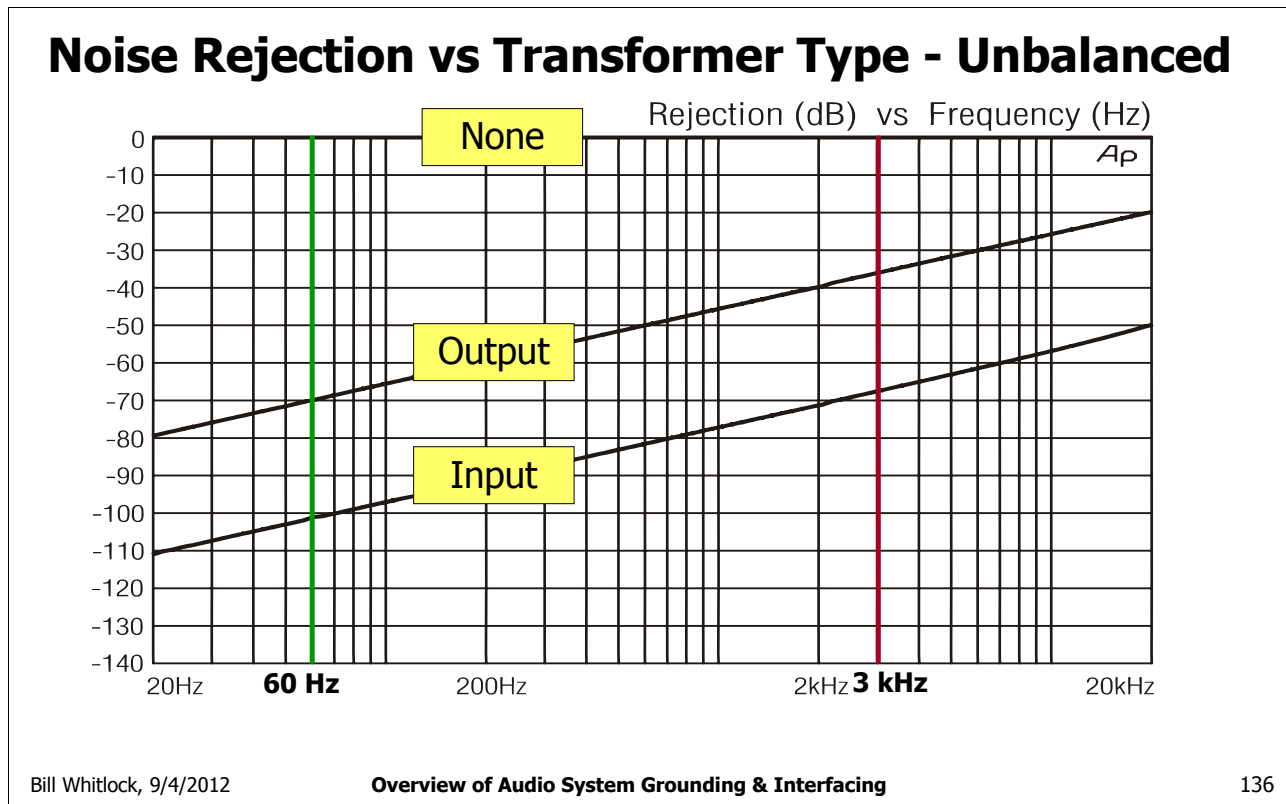

**Input type gives 30 dB better noise rejection at all audio frequencies.**



### Commercial Ground Loop Isolators - Unbalanced

- Overwhelming majority use unshielded **output** transformers
- Many units use tiny \$2 transformers designed for telephone couplers, where 300 Hz to 4 kHz "flat" response is enough
  - Device below typical of many low-cost "ground loop isolators"
  - Data lists details like DC resistance but doesn't even mention **noise rejection** ... which is the main reason isolators exist!



Radio Shack 270-054 at \$20

Ground LP Isolator (270-054) from <http://support.radioshack.com>  
 Specifications, ELECTRICAL DATA:  
 Impedance Ratio: Z1:Z2.....1000 Ohms:600 Ohms  
 Frequency Response:.....300 Hz to 4000 Hz +/- 3 dB  
 DC Resistance @25 degrees C:  
 Z1:.....200 Ohms +/- 20%  
 Z2:.....150 Ohms +/- 20%  
 Insulation:.....500 VDC apply to primary and secondary  
 more then 100 Meg Ohms Min.

**The Radio Shack unit is popular with car stereo installers** (but not in **my** car)

## Specifications often “Deceive by Omission”

- When inappropriately-designed (usually cheap) transformers are used in high-quality audio systems, the result is:
  - Loss of deep bass
  - Distorted bass, especially during loud passages
  - Poor high-frequency transient response and imaging
- But their so-called “specifications” are often just a feature list that omits the “dirty little secrets” of their poor performance!
- **Audio transformers intended for professional use should, above all, have complete and unambiguous specifications!**

## Beware of "Sketchy-Specs"

- Noise Rejection or CMRR
  - Meaningless without stated source impedance and frequency
- Maximum Signal Level and Distortion
  - One strongly affects the other
  - Both also depend on driving source impedance and frequency
  - **Any P.O.S. transformer will have low distortion at any signal level when it's driven from a very low or zero-impedance source and at a midrange frequency like 1 kHz!**
  - **Ask how much signal it will handle at 20 Hz or 30 Hz, while keeping distortion under 1% THD, when driven from a real-world source – THAT'S WHAT REALLY MATTERS!**
- Frequency Response
  - Again, since source and load impedances strongly affect response, specs are meaningless unless both are stated

Bill Whitlock, 9/4/2012

Overview of Audio System Grounding & Interfacing

139

**Maximum signal level and distortion are the transformer specifications most deceptively advertised and listed by our competitors. Many won't even mention CMRR, let alone disclose the test conditions. After all, NOISE REJECTION is the top reason for using a transformer at interfaces in the first place!!**

## Typical “Sketchy-Specs” Information\*

- The entirety of published electrical data for a stereo “Hum Killer” offered for “professional” use:
  - **TYPICAL PERFORMANCE:**
  - Inputs (2): –10 dBV nominal, 10 k $\Omega$
  - Outputs (2): –10 dBV nominal, 10 k $\Omega$
  - Frequency Response: 20 Hz to 20 kHz (+/– 3 dB)
  - THD+N: <0.5% (30 Hz to 20 kHz); 0.05% @ 1 kHz
  - Crosstalk: <60 dB (20 Hz to 20 kHz; 100  $\Omega$  source, 10 k $\Omega$  load); <70 dB @ 1 kHz
- Only crosstalk could possibly be verified (test conditions are stated) – **the rest is meaningless and most likely hiding the ugly truth!**

\* **Sketchy**: wanting in completeness, clearness, or substance; slight, superficial. (merriam-webster.com/dictionary)

Data from [http://www.rdl.net.com/pdf/Data\\_Sheets/av-hk1.pdf](http://www.rdl.net.com/pdf/Data_Sheets/av-hk1.pdf) on 15 May 2012.

## Honest, Complete Specifications

- Isolator for unbalanced audio interfaces
- Faraday-shielded **INPUT** transformers
- Out cable  $\leq 3$  ft for rated HF bandwidth
- It has real specifications:



*Jensen Transformers*

### **ISO-MAX® Model CI-2RR Condensed Specifications**

*(see [www.jensen-transformers.com/datashts/ci2rr.pdf](http://www.jensen-transformers.com/datashts/ci2rr.pdf) for complete version)*

**Test conditions: 600  $\Omega$  source, 47 k $\Omega$  load, 1.23 V rms level unless noted**

**Frequency Response, ref 1 kHz:** - 0.15 dB at 20 Hz, - 0.7 dB at 20 kHz

**Bandwidth, - 3 dB, ref 1 kHz:** 0.25 Hz to 50 kHz

**Total Harmonic Distortion:** 0.04% typ at 20 Hz, <0.001% typ at 1 kHz

**Max Input Level, THD < 1%:** 7 V rms at 20 Hz, 11 V rms at 30 Hz

**Noise Rejection (CMRR):** 95 dB typ at 60 Hz, 85 dB typ at 3 kHz

**Phase Distortion, 20 Hz ~ 20 kHz:**  $\pm 2^\circ$  max deviation from linear phase

**Notice that the ability to handle large signals is very frequency dependent. Who but Jensen would dare mention phase distortion? If you want to know more about "deviation from linear phase" or DLP, just ask us for a copy of the paper by the late Deane Jensen. It explains why "phase shift" is not necessarily phase distortion.**

## “Active” Amplifier-Based Isolators



RDL

- Many powered or “active” devices claim to cure ground loop problems in balanced or unbalanced interfaces, but
- This unit touts an “instrumentation” input stage, but its low CM input  $Z$ , 5 k $\Omega$  per leg, cause its noise rejection to be exquisitely sensitive to the slightest  $Z$  imbalance in “balanced” signal sources
  - With unbalanced sources, their entire output impedance,  $Z_o$ , typically 200  $\Omega$  to 2.2 k $\Omega$ , becomes  $Z$  imbalance
  - Even if properly connected to an unbalanced source, over that same  $Z_o$  range, **CMRR will range from 28 dB to as little as 7 dB**
  - However, the manufacturer’s recommended hook-up for unbalanced sources results in **zero noise rejection** (*more on this later*)

We’ll talk about “**diff-amps**” in the section on **balanced** interface line receivers.

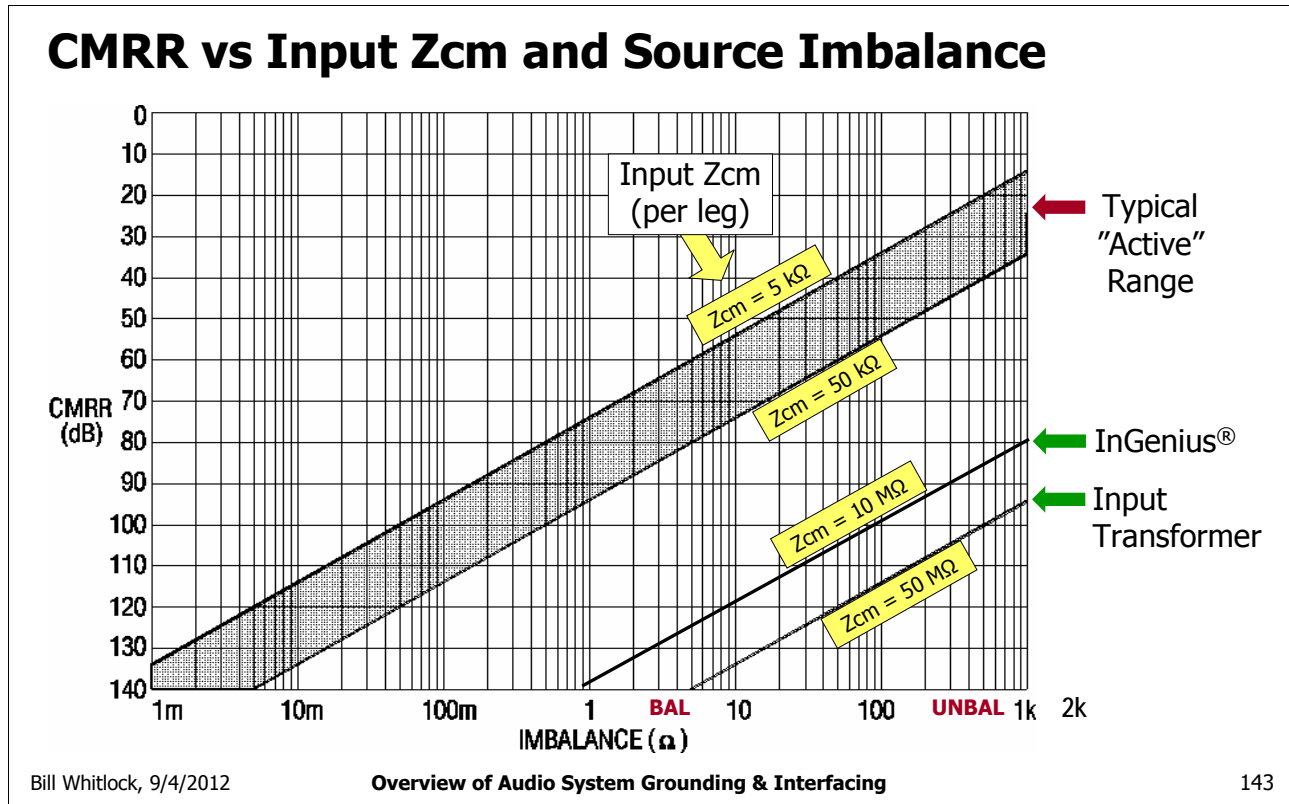

**This graph shows the fundamental relationship that limits CMRR for any combination of receiver common-mode input impedance (per leg) and driver common-mode output impedance imbalance.** These are calculated results that assume that all system components are ideal. The performance of actual circuits will generally be very close to these CMRR numbers.

## Floating Equipment vs Isolators

- The chassis of devices with 2-prong AC plugs can "float" at 50 VAC or more (relative to safety ground) if no ground path exists
  - This often happens when an isolator is installed at an interface
  - No shock hazard because available current is very low
- This "float" voltage is an extreme challenge for an isolator – the common-mode voltage can be 100 times larger than the signal
  - This unavoidably degrades its noise rejection by about 40 dB!
- **An added equipment ground solves the problem**
  - Replace the original 2-prong AC plug with a new 3-prong type
  - Add a wire connecting the ground pin of the new AC plug to the chassis of the ungrounded equipment
    - Recommended wire: #18 or #20 AWG, stranded, with green (or green w/yellow stripe) insulation. Wrap it around original 2-wire cord in a long spiral and connect with a lug to a rear-panel screw-head.

Bill Whitlock, 9/4/2012

Overview of Audio System Grounding &amp; Interfacing

144

Since an isolator has no electrical connection between its input and output, the ground path previously provided by the signal cable vanishes when the isolator is installed in the signal path. Remember that **CMRR is a ratio** comparing an isolator's response to a normal signal to its response to the same voltage applied as a common-mode (or ground voltage difference) voltage. If the ground voltage difference is now 100 times that of the signal (40 dB larger), the noise rejection of the isolator will be 40 dB worse! It explains why an occasional customer will call to tell us that the buzz got worse when the isolator was installed!



## Grounding "Floating" Devices

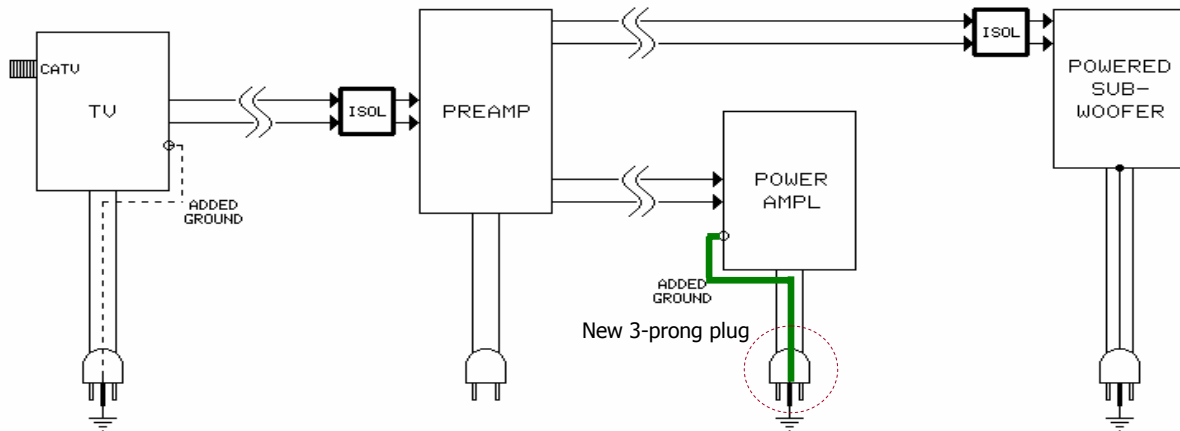

Added ground shown in green removes "floating voltage" from the **PREAMP** and **POWER AMPL**, allowing rated noise rejection in isolators shown. If the **TV** had a CATV isolator at its input, there would be no need to replace its 2-prong plug and ground it or to use the **TV** to **PREAMP** isolator.

**Without an added ground, the isolators allow the preamp and power amp to "float" with respect to the TV or sub-woofer, placing a huge noise-rejection burden on the isolators.**

## Tips to Avoid Noise in Unbalanced Interfaces

- Keep cables short and do not coil excess
- Use cables with heavy gauge shields
- Maintain good connections
- Do not add unnecessary grounds
- **Never, ever disconnect a safety ground!**
- Use ground isolators at problem interfaces
- Bundle all signal cables between same two boxes
- Bundle AC power cords separately
- Separate signal and power bundles by at least 6 inches

Longer cables have more shield resistance end-to-end, which produces more common-impedance coupling. Coiling excess cable invites magnetic induction from any nearby motor or transformer (better to fold and bundle cables that are too long). For long cable runs, use cable with lots of heavy copper braid as shielding to keep resistance down. Bonded-pair stereo or RGB video cables are a good idea because they reduce magnetic pickup area just as bundling all signal cables between same boxes does. Although AC power cords actually radiate very little magnetic field, when many are bundled together the magnetic field tends to drop even further due to averaging. If signal and power bundles (or individual cables) must cross, arrange for them to cross at 90° angles. Gently wiggling connectors will often reveal intermittent problems. **Adding grounds not required for safety will almost always make noise problems worse!** The only exception is a ground added to equipment having a 2-prong AC plug to limit common-mode voltage as discussed earlier. Ground isolators at signal interfaces are the "silver bullet" solution for ground-loop noise ... because they directly solve the fundamental coupling problems.

## Unbalanced to Balanced Transitions

- Also called "Consumer to Pro" conversion
- Signal reference levels are different
  - Consumer ref =  $-10$  dBV (or  $-7.8$  dBu) =  $0.316$  V rms
  - Professional ref =  $+4$  dBu (or  $+1.8$  dBV) =  $1.228$  V rms
  - Requires voltage gain of about 4, or 12 dB
    - $0$  dBu =  $0.775$  V rms
    - $0$  dBV =  $1.000$  V rms
    - **$0$  dBV =  $+2.2$  dBu**
- **Why not use a 1:4 step-up transformer you ask?**

## “Consumer to Pro” Converter?



Rane Corp.

**NOT A GOOD SOLUTION**

- Uses a 1:4 step-up transformer
  - A 1:4 transformer reflects  $(1:4)^2$  or a 1:16 impedance ratio
  - For balanced  $Z_{in}$  from 10 k $\Omega$  to 40 k $\Omega$ , the consumer output sees loads from 625  $\Omega$  to 2.5 k $\Omega$  while IEC standards specify 10 k $\Omega$  rated load
- Overloading degrades headroom, distortion, and frequency response
- Actual gain isn't the expected 12 dB, but only 3 to 8 dB
  - 12 dB of gain "reach" is normally available for balanced inputs, making external gain generally unnecessary

Bill Whitlock, 9/4/2012

Overview of Audio System Grounding & Interfacing

148

**The Rane engineering staff is fully aware of my comments about this product.** They've defended it by saying that they keep selling them! And they're not the only one – Ebtech also sells a similar product and my criticism would apply to it as well. The problem is theoretically insurmountable. **If gain is actually required, it should come from an amplifier of some sort.**

## Close, But No Cigar ... or Noise Rejection!



RDL

- Just as with a simple RCA to XLR adapter, all noise-rejection benefit of its balanced input is lost
- In this case, an easy change to this wiring could add 7 dB to 28 dB of rejection!

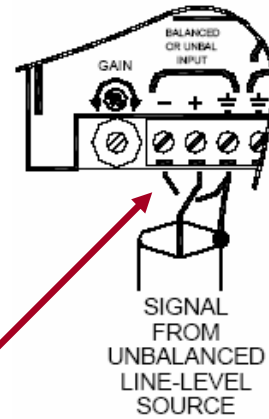

from "Installation/Operation" page for RDL Model STA-1M with "Instrumentation Input to Isolate Ground Loops"

## Again ... Close, But No Cigar!

- Internal wiring of this “Audio Format Converter” renders its internal audio transformer useless
- **Input shield is tied to output pin 1**, which allows noise current to flow in the incoming cable shield ... exactly how noise couples to the signal!
  - No useful isolation
  - No voltage gain
  - No output voltage symmetry
    - No Faraday shield, bifilar winding instead (precluding symmetry)

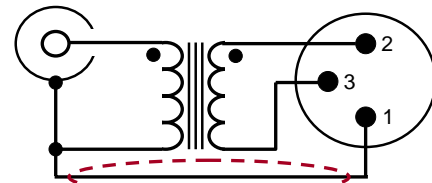

Internal Schematic

Because the input and output grounds are tied, no “isolation” or common-mode rejection is possible. Because the transformer ratio is 1:1, there can be neither impedance matching nor voltage gain. Because the transformer has no Faraday shield (it is bifilar wound instead), it can’t create voltage symmetry. If it doesn’t perform one of these useful functions, what value does it have?

## Simple but Smart Transition or “Converter”

- Transition and noise rejection are the issues, not gain
- “Adapters” and most “adapter cables” throw away the noise reduction benefit of the balanced input
  - An **RCA to XLR adapter** at a balanced input converts the entire interface to a noise-prone unbalanced one!
- A 3-conductor (shielded twisted-pair) hookup allows the balanced input to reject ground noise
  - If the balanced input uses an input transformer or the InGenius® IC, noise rejection can be over 90 dB!
  - Even if the balanced input is only a “garden variety” diff-amp or instrumentation-amp, rejection is still typically **30 dB**

## 2 Conductors ... or 3?

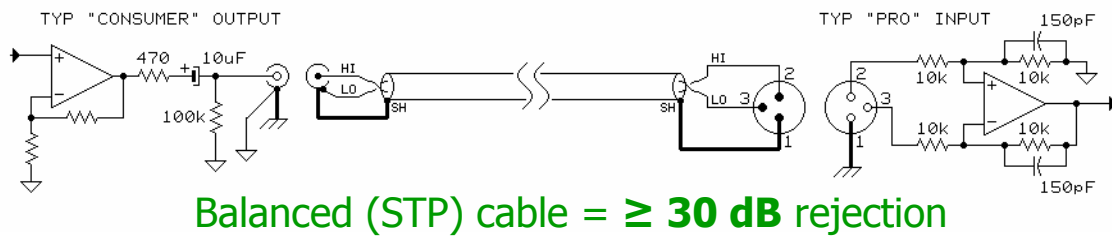
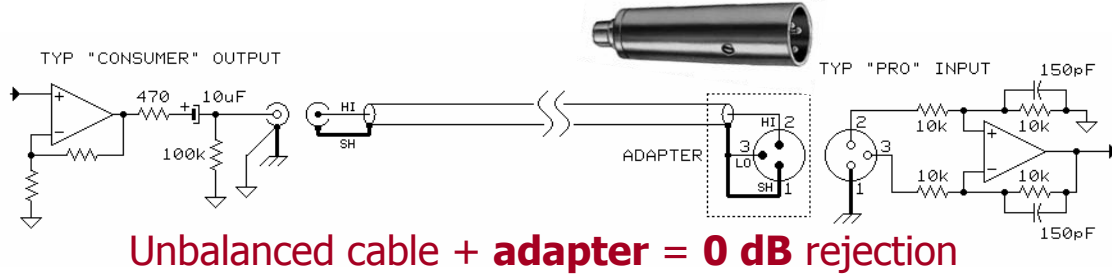

**The mere existence of these adapters makes people think it's the right thing to do ... it's definitely NOT! And makers of "adapter cables" generally don't GET IT either ... continuing to make cables with single-conductor shielded cable with an adapter essentially built-in at the XLR end ... DUMB!**



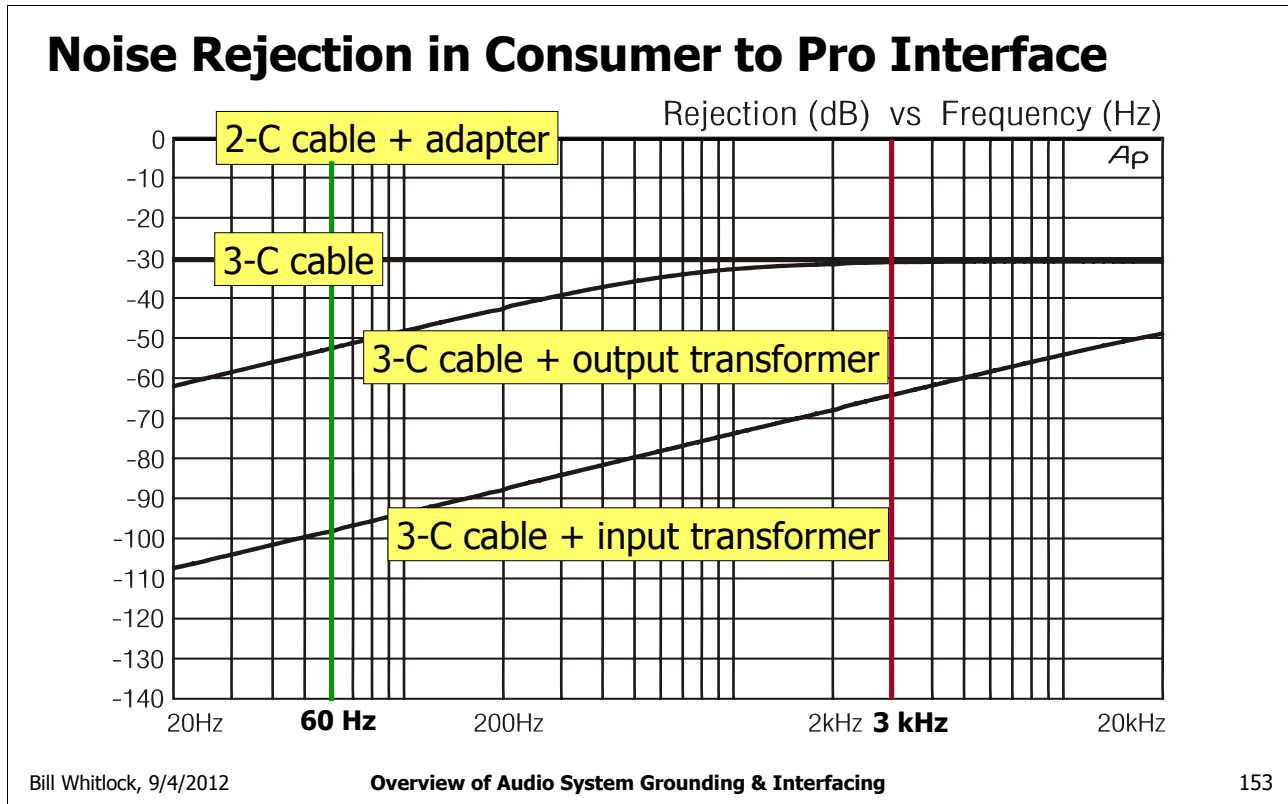

**Input transformer adds 70 dB of hum and 35 dB of buzz rejection. Standard (output) transformer improves hum by about 20 dB but does essentially nothing for buzz.**

## Should I “Balance” an Unbalanced Line?

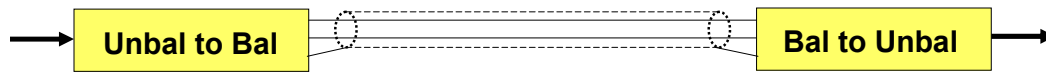

- **NO – two converters on same line completely unnecessary**
  - This myth is based on the superficial idea that signal symmetry somehow has anything to do with noise rejection and wrongly assumes that cheap “balun” transformers create such symmetry ... they do not!
- An input-transformer-based isolator at the receive end will have much better noise rejection than a pair of “baluns”
  - Creates a high-rejection, source-impedance tolerant balanced input at the receive end of line
  - The line itself, whether coaxial or twisted-pair, is not more vulnerable to noise because “it’s not balanced” at the send end!

**Buying two “baluns” to fix noise on an unbalanced line is a waste of money!  
And you don’t need new cable either!**

## ISOLATORS for Balanced Audio

- Solve the two most common problems with balanced interfaces:
  - **Equipment "Pin 1 problems"**
  - **Low CMRR in the real world**
- This isolator solves both
  - DIP switches (on bottom) can reconfigure **shield** connections to solve Pin 1 problems
  - Uses Faraday-shielded **INPUT** transformers boost CMRR, typically by 40 to 60 dB



The 2-channel model PI-2XX is shown.

## Getting High CMRR in the Real World

- Real-world **interface CMRR** will likely be much less than advertised for the balanced input alone!
  - The “marketing” CMRR figure is **VERY MISLEADING**
- **INPUT** transformers have a BIG advantage!
  - Zcm of a **real** input transformer is about **50 M $\Omega$**  at 60 Hz – 1,000 times that of ordinary “active” inputs – making them very source tolerant
  - **Interface CMRR** is essentially unaffected by 500  $\Omega$  imbalances and little affected up to 2 k $\Omega$ , allowing sources to be either balanced or unbalanced



the author's license plate

**Real-world audio equipment is not made with the precision of laboratory test instruments, so conventional tests for CMRR are nearly meaningless.**

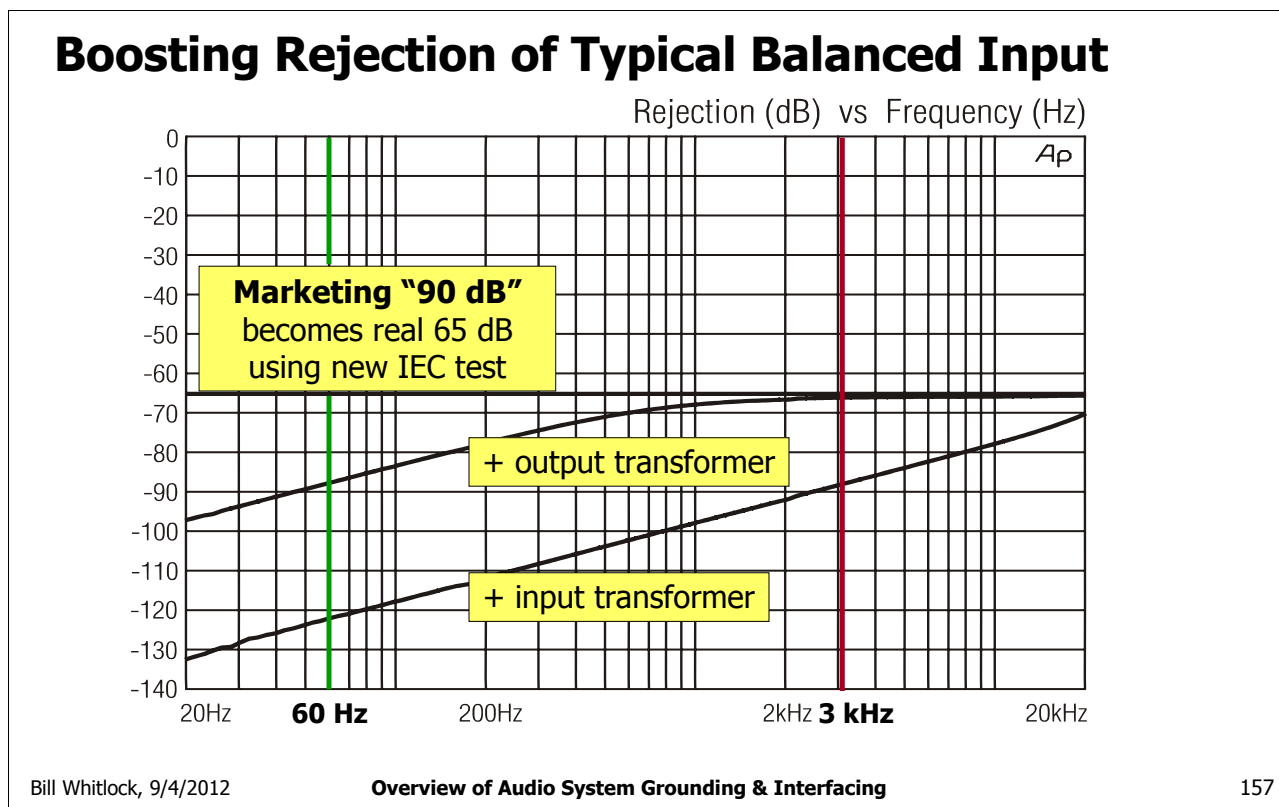

The **input** transformer, which has an internal Faraday shield, does about 35 dB better than a commodity **output** type. **The output type improves hum rejection by about 20 dB but does nearly nothing for buzz.**

## Commercial Ground Loop Isolators – Balanced



- Again, Beware of “sketchy-specs” that hide the ugly truth
- Overwhelming majority of isolators use **output** transformers
  - As shown in the graph, such units do nothing for “buzz” and little for “hum”
  - In fairness, they have one possible advantage – they can be installed without regard for output cable length, making it a “no-brainer”
- Many isolators simply can’t handle professional signal levels ...

**Is there a hidden message in the fact that “buzz” isn’t mentioned?**

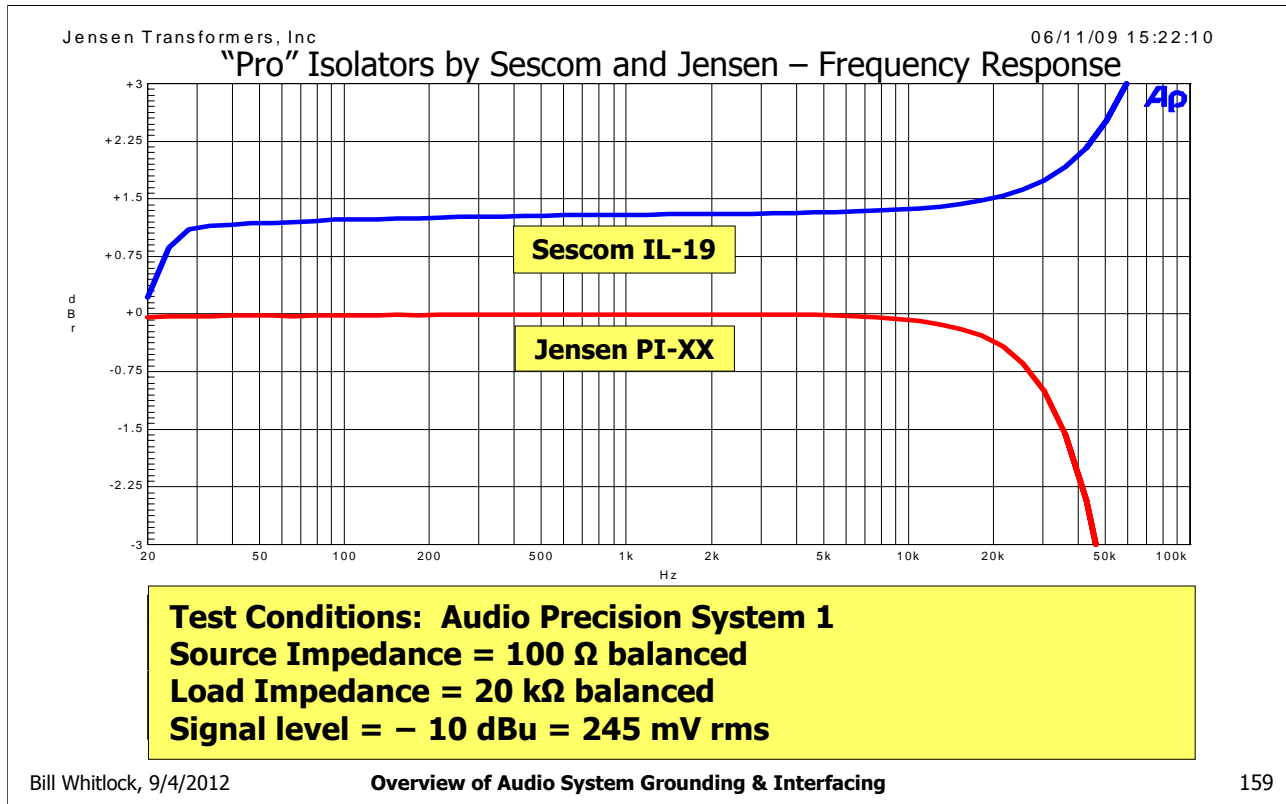

Both the Jensen ISO-MAX® model PI-XX and the Sescom model IL-19 are isolators with XLR input/output connectors and intended for "professional" applications. The Jensen model uses the exact same (model JT-11P-1HPC) transformer as the model CI-2RR "consumer" isolator shown in the previous slide. The gradual drop in its high-frequency response is intentionally designed to give it a second-order Bessel rolloff, which accounts for its impeccable time-domain response ... seen as square-wave response without overshoot or ringing. It is standard measurement practice to measure frequency response at a low signal level to avoid confusing the results with overload – magnetic saturation in this case.

On the other hand, the Sescom IL-19 has a huge frequency response peak in the vicinity of 100 kHz. This will not only result in square-wave overshoot and ringing but such peaks can also cause or aggravate "spectral contamination" distortion in downstream amplifiers. Ask us for a copy of the 1988 AES paper "Spectral Contamination Measurement" by Gary Sokolich and the late Deane Jensen. Also note that the IL-19 frequency response falls sharply at about 30 Hz. It would no doubt be flat at a lower signal level, but at only -10 dBu (equals 245 mV rms) the 30 Hz signal has magnetically saturated the transformer core. This magnetic saturation manifests itself as high THD at 30 Hz in the next slide.

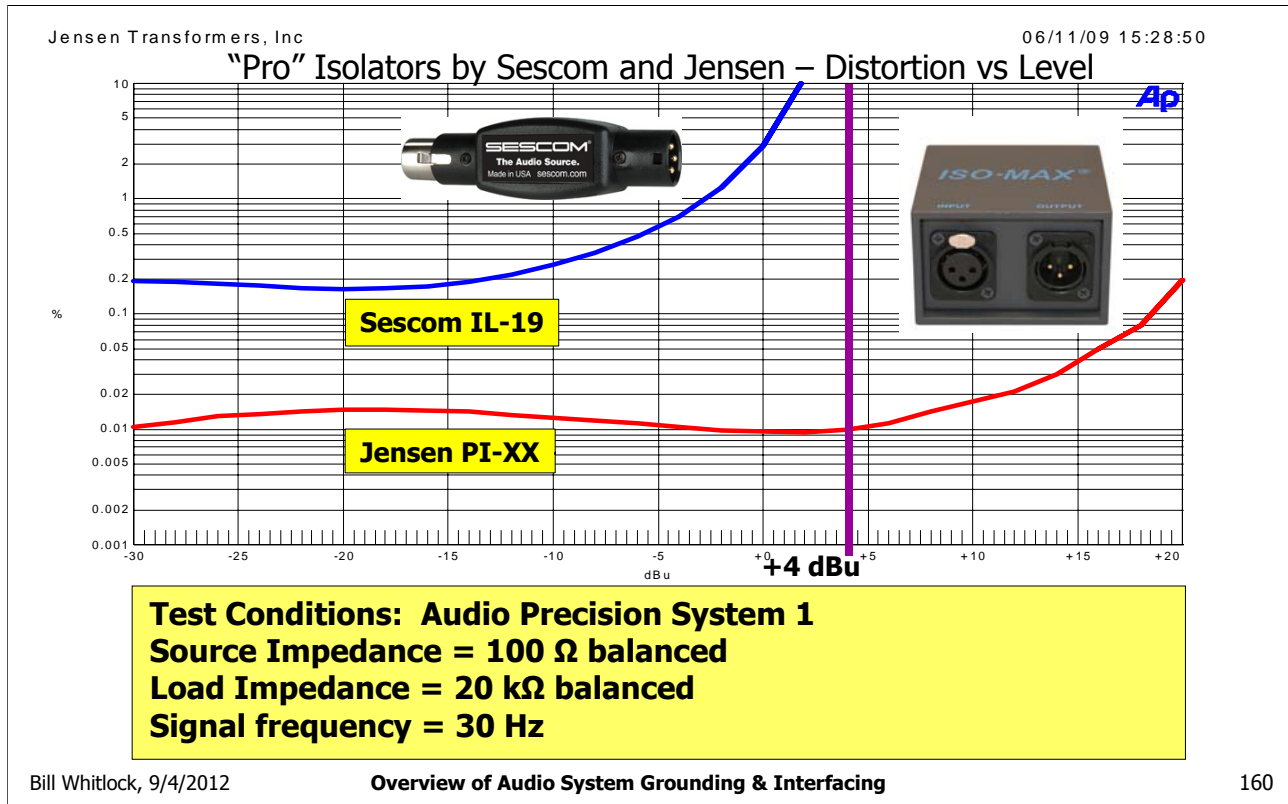

High distortion at low signal levels is a property of inexpensive core materials like steel. Reaching over 10% distortion at the nominal "pro" operating level of +4 dBu (shown by purple line) indicates that the IL-19 transformer core is far too small. **Ad copy for the IL-19 makes a big deal of "headroom," but at bass frequencies, there is no headroom at all!** Although the Jensen is larger, and a bit more expensive, it has some 20 dB of real headroom and remains sonically transparent in even the most demanding audiophile systems! **In general, it's impossible to make a high-performance audio transformer that will fit into an XLR barrel.**



## Isolators: “Friends with Benefits”

- Benefits of **INPUT** type transformers
  - Noise rejection over 80 dB, whether the signal source is balanced or unbalanced
  - Filter out ultra-sonic and RF interference, reducing “spectral contamination”
  - Solve “Pin 1 problems”
  - No power required
  - Simple, passive, robust, reliable, and virtually immune to transient surges

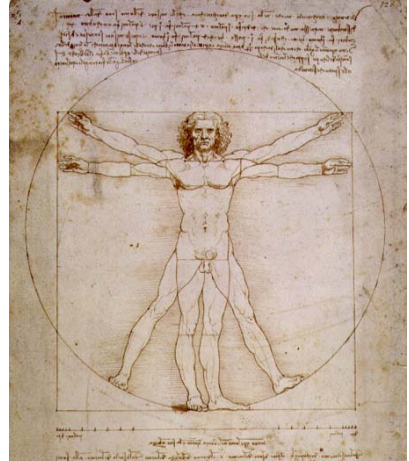

**“Simplicity is the ultimate sophistication”**

**Transformers have no concept of “ground” – they “don’t care” whether a signal source is balanced or unbalanced.**

## The Balanced Interface Checklist

- Twisting of all balanced line pairs
  - Provides immunity to **magnetic** fields
  - Especially important in low level microphone circuits
    - **Terminal blocks and XLR connectors vulnerable to magnetic fields**
    - **"Star-Quad" magnetic pickup  $\approx$  40 dB less than STP**
  - Provides immunity to **electric** fields for unshielded pairs
- Be careful with cable shield grounding
  - ALWAYS at DRIVER
  - OK at BOTH
  - NEVER at RECEIVER ONLY

## Balanced to Unbalanced Audio

- Also called "Pro to Consumer" or "+4 to -10" converter
- **Signal level difference is a legitimate concern**
  - Consumer inputs are easily over-driven by pro levels
  - Interface requires voltage loss of 12 dB
  - If pro output level is reduced, metering and S/N are degraded
  - Resistor "pad" can be used but provides no isolation
- **Variety of balanced output circuits make direct connections risky!**
  - Some will misbehave or be damaged if either output line is grounded
  - "Servo-balanced" or transformer outputs **must** have one line grounded to drive an unbalanced input
    - Grounding one line at the driver reduces the entire interface to unbalanced, making it vulnerable to ground noise
    - "Servo-balanced" outputs (SSM2142 and clones) may become unstable if one line is grounded at receive end of cable, which is necessary to reject noise

Bill Whitlock, 9/4/2012

Overview of Audio System Grounding & Interfacing

163

**Making this transition with a CABLE ALONE is indeed RISKY BUSINESS!** The 12 dB voltage loss IS a big deal. Recall that +4 dBu is "pro" signal reference level and that -10 dBV is "consumer" signal reference level.

## “Universal” Pro to Consumer Converter

- Interface works with **any output stage**
- Step-down 4:1 **input** transformer attenuates signal 12 dB
- Superior noise rejection

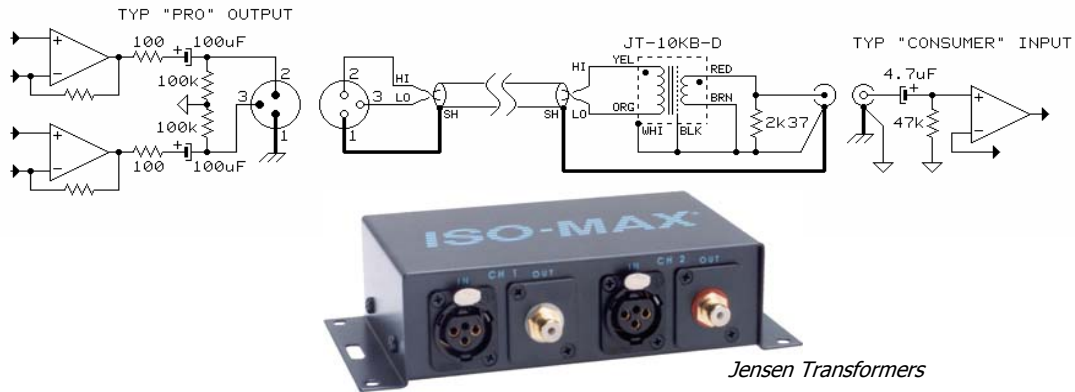

Bill Whitlock, 9/4/2012

Overview of Audio System Grounding & Interfacing

164

**The 2-channel model PC-2XR is shown.** It's available with various other input and output connectors – or it can be permanently wired using the detachable screw-terminal strip (on its rear).

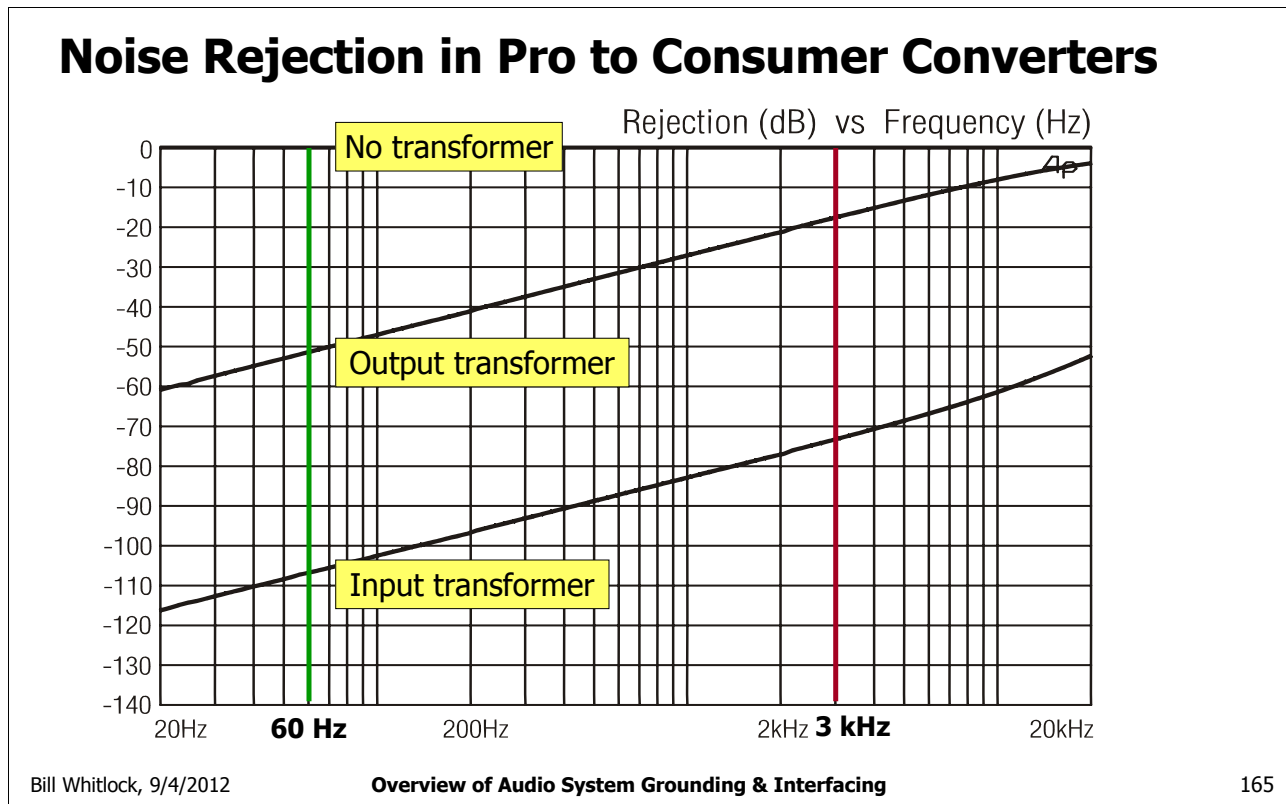

**Again, the INPUT transformer performs some 50 dB better than an output transformer.**

## Solutions for Analog Video

- Objective is to reduce voltage drop over the length of the video cable
  - Reduce ground voltage difference (AC power work may be expensive)
  - Reduce cable length (may not be possible)
  - Replace cable with lower shield-resistance type
  - Use an isolator in the signal path to reduce ground loop current
- There are 3 types of isolators, each with its own tradeoffs
  - **Baluns for video over UTP generally have no isolation**

## 1 – Video Isolation Transformer

- Magnetically couples signal across an electrically-insulated barrier
  - Signal bandwidth 10 Hz to 10 MHz is near limits of technology
- Extremely high common-mode impedance at 60 Hz
  - Effectively **stops** ground loop current and has very high CMRR
- Tolerates extreme ground voltage differences
  - 300 V-rms typical, limited only by internal insulation
- Suited for **composite** or S-video, even when ground voltage difference is very high and/or cables are very long
- Wide application in surveillance and security TV
- Lowest cost

Security and surveillance video is a primary market for these units.

## Video Isolation Transformer

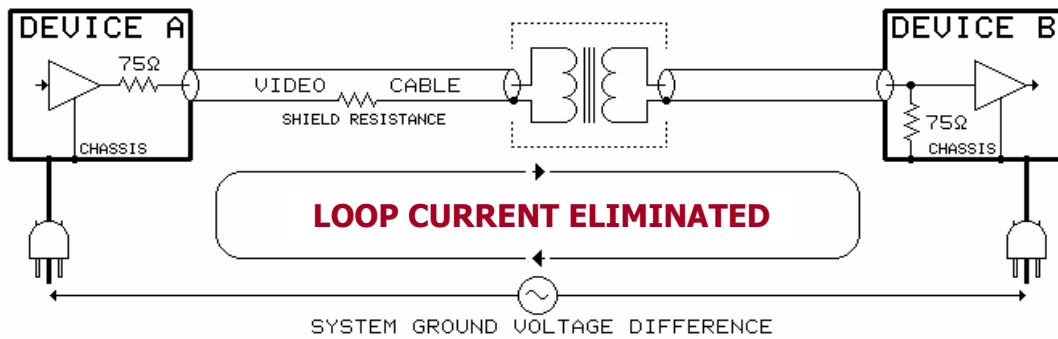

Bill Whitlock, 9/4/2012

Overview of Audio System Grounding & Interfacing

168

True transformers will tolerate the highest ground voltage differences of the 3 solutions. **The Jensen VB-1BB will withstand 300 V between input and output, but this is obviously a safety hazard and not recommended.**



## Composite Video Isolation Transformers



*Jensen Transformers*



*RDL*

**There are also models available for S-VHS format.** These transformers find their main application in security systems.

## 2 – Video Common-Mode Choke

- Called “hum eliminator,” “hum suppressor,” “hum-bucker,” “ground loop inhibitor”, and (mistakenly) a “transformer”
- **Fundamentally different from a transformer**
- Signal not converted to magnetic field, only ground voltage difference produces magnetic field in its core
  - **Maximum ground voltage difference limited by core saturation**
  - **Most will tolerate up to 2 V rms, but some less than 200 mV rms**
- “Windings” actually a length of miniature coaxial cable
  - LF response extends to 0 Hz (DC)
  - HF response determined by coax, typically >400 MHz
- **Suited for high-resolution component or computer video**

## Video Common-Mode Choke

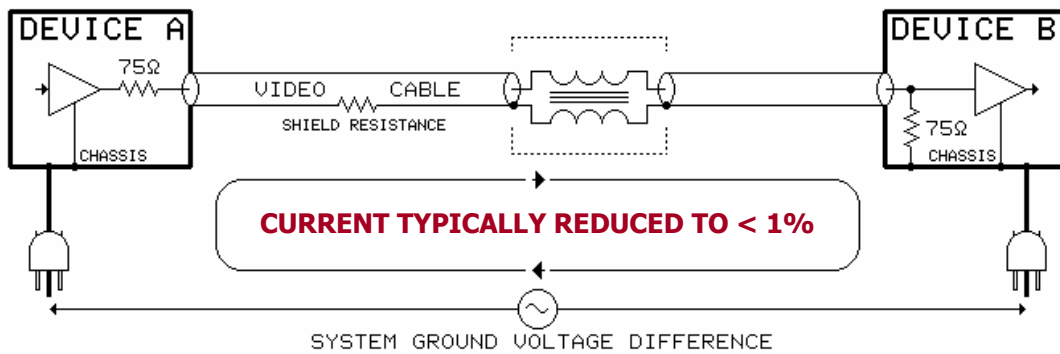

## Video Common-Mode Chokes

3 and 5-Channel Units for RGB, RGBHV, etc.

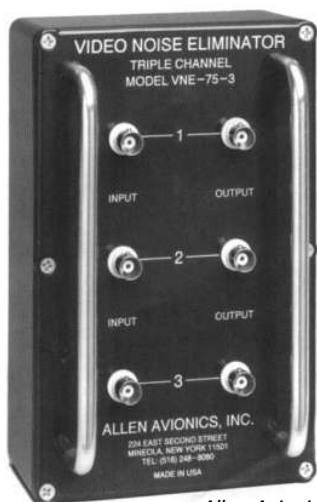

*Allen Avionics*



*Jensen Transformers*

**"Breakout cables"  
allow use with  
computer video  
signals**

**The 3-channel Jensen VBH-3RR and the 5-channel VBH-5BB are shown here. The channels on these units are completely independent electrically. Single-channel units are also available and are often used on SDI video interfaces.**

### 3 – Video Isolation Amplifier

- Called “hum-bucking” or “differential-input” amplifiers
- Use wideband diff-amp to provide CM voltage rejection
- CMRR is affected by accuracy of the  $75\ \Omega$  source and cable resistances (a function of their length)
  - “Trim” adjustment necessary for best rejection
  - Require power and use semiconductors, making them potentially vulnerable to transient voltage damage
- Bandwidths typically range up to 200 MHz
- Often have useful features like multiple outputs and adjustable gain

## Video Isolation Amplifier

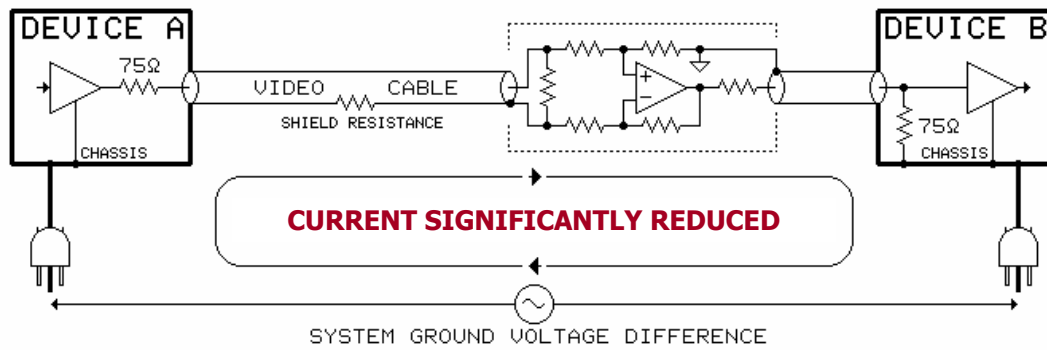

## Video Isolation Amplifier



*Video Accessory Corp.*

**The unit pictured is VAC part number 100-0-007.**

## How Much Overall System Bandwidth?

Source	Format	Resolution @ FPS	BW
VHS	NTSC	240 L @ 30	4 MHz
Broadcast	NTSC	330 L @ 30	6 MHz
Broadcast, DVD	SDTV 480i	720x480 @ 30	15 MHz
Prog DVD	EDTV 480p	720x480 @ 60	30 MHz
Computer	XGA	1024x768 @ 60	71 MHz
HDTV, DVD	720p	1280x720 @ 60	83 MHz
HDTV, DVD	1080i	1920x1080 @ 30	93 MHz
Computer	SXGA	1280x1024 @ 60	118 MHz

*Courtesy Peter Putman*

Peter Putman is a video expert who writes for SVC and other magazines.



## Video Isolator Considerations

- System bandwidth required
- Length and type of existing cables
- Voltage difference across the interface
- Remember (for all types of devices):
  - Noise rejection will decrease with cable length
  - **Ground voltage difference may exceed isolator capability**
  - Cables themselves limit overall bandwidth
  - Critical specs may be conspicuously absent or unqualified as to test conditions – beware the “sketchy-spec” syndrome!
- **Baluns** for video over UTP generally provide **NO isolation!**

**Not surprisingly, marketing obscures the truth about many of these products, too.**

## Cable TV Grounding

- Requirements of NEC Article 820
  - Coaxial cables entering a building must have their outer sheaths grounded as close as practicable to their point of entry
  - Grounding wire must be as short as possible, insulated, and have current-carrying capacity equal to the shield of the coaxial cable – no smaller than #14 AWG, but larger than #6 AWG is not required
  - Bond to main power grounding electrode if within 20 feet
  - If not, an 8-foot ground rod must be used **and bonded to main power grounding electrode with #6 AWG or larger wire**
  - A metallic water pipe, **if within 5 feet of where it enters the building**, may be used as a grounding electrode
  - All such lightning ground wiring should be as straight as possible, using gentle curves rather than sharp bends
  - PVC conduit is preferred for physical protection of this wiring

Same comments apply regarding #6 bond wire and protection of wiring.

## Satellite Dish Grounding

- **Requirements of NEC Article 810**

- Outdoor masts or antenna supports must be grounded
- Signal cables must use listed "antenna discharge unit" (grounding block) located as near as practicable to the point of entrance, inside or outside
- Grounding wires to be no smaller than #10 AWG copper or #17 AWG copper-clad steel, need not be insulated, and may be outside or inside the building
- Bond to main power grounding electrode if within 20 feet
- An 8-foot ground rod may be used but it **must be bonded to the main power ground electrode with #6 AWG or larger**
- An interior metallic water pipe, **if within 5 feet of where it enters the building**, may be used as a grounding electrode
- Ground wiring should use gentle curves, not sharp bends
- PVC conduit is preferred for physical protection of this wiring

The NEC requirements are often modified by local "authorities having jurisdiction" or AHJs.

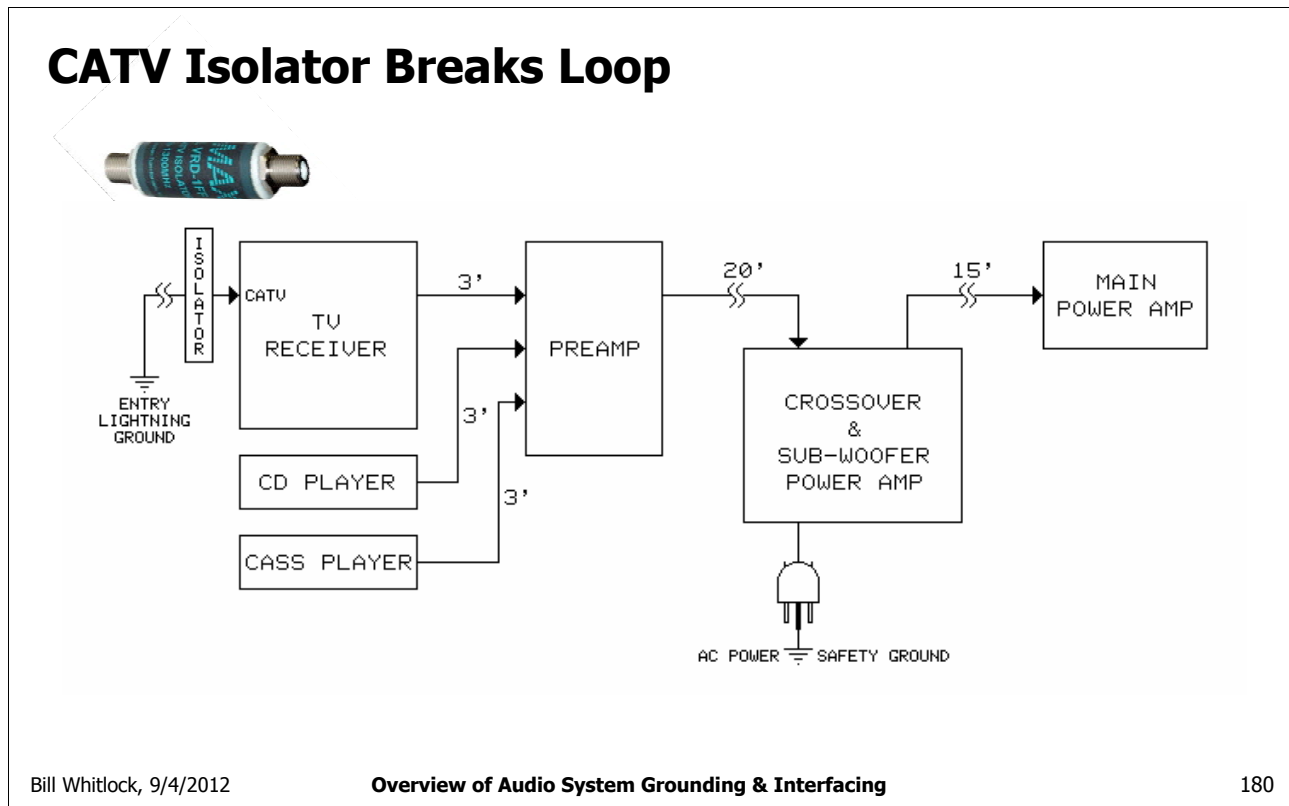

**The VRD-1FF is shown.**

## CATV/Cable Modem Isolators

- Also used on TV/FM/MATV antenna cables
- **Must be downstream of lightning ground connection**
- **Splitters** connect all shields, enabling ground loops **between** systems
  - Prevent loops with an isolator at each destination
- Beware of “sketchy-spec” isolators – some are truly awful!
  - Two 75  $\Omega$  to 300  $\Omega$  matching transformers back-to-back is particularly bad
- **Isolators will not work between DBS dish and receiver!**
  - They block DC power to dish

**A popular DIY isolator uses two back-to-back 300 $\Omega$  to 75 $\Omega$  converters ... and has really horrible frequency response!**

### CATV Isolator Specifications

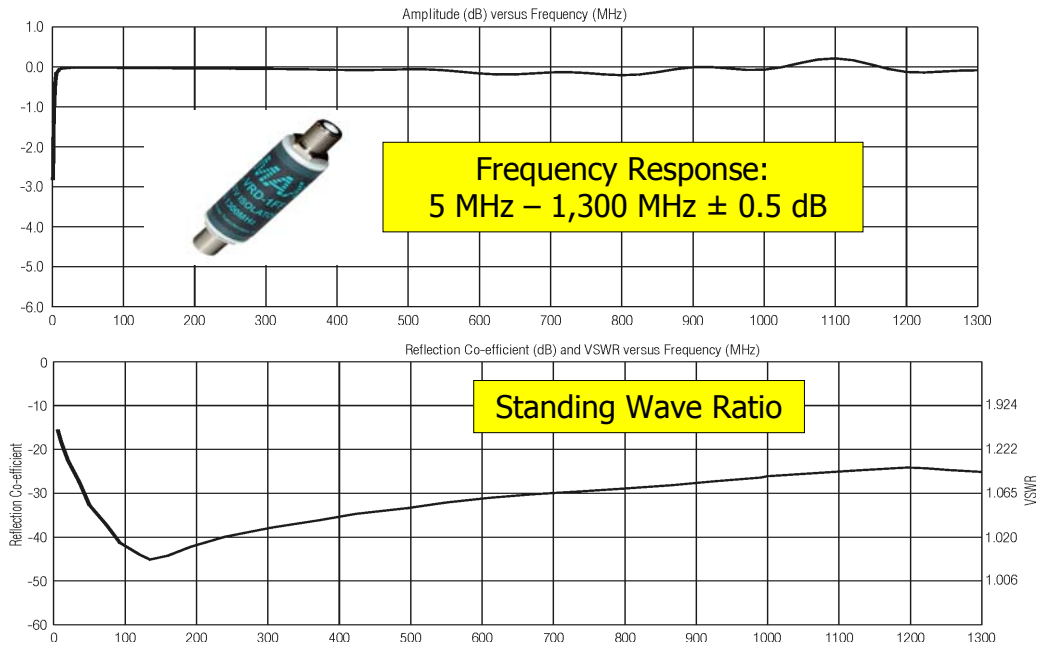

Bill Whitlock, 9/4/2012

Overview of Audio System Grounding & Interfacing

182

**VSWR and Reflection Coefficient are measures of 75Ω impedance accuracy. VSWR under 1.2 is considered excellent.**

## Satellite System Isolation

- **Satellite dish must be grounded per NEC section 810**
- “Isolated Grounding Block” or IGB allows dish and downloads to remain **safely ungrounded** under normal conditions
- If DBS receiver has 3-prong AC plug, that’s a separate issue that may require isolators at receiver outputs – in which case no IGB is needed

## The Isolated Grounding Block



Ground circuit remains open until voltage reaches 90 volts, which ionizes the gas-discharge tube that can sustain 18,000 A surge. It then automatically re-opens, ready for the next "event."

To Ground Connection

**NOTHING can fully protect from direct strikes that can reach 150,000 A**

**The GI-2FF is a new model this year!**



## Ground Loops and Data Interfaces

- **RS-232 digital interface is unbalanced**
  - Since it's digital, noise symptoms are usually deemed "unexplainable"
  - Since it's unbalanced, ground noise voltage directly adds to the signals
- RS-422, RS-485, and USB are balanced but their common-mode voltage range is quite limited
  - Shielded cables, grounded at both ends can help reduce common-mode voltage, especially at high frequencies
  - Ethernet uses integral isolation transformers ... making it very robust
- Many data line isolators are optically-coupled and can withstand ground voltage differences up to 2 kV

**Unbalanced interfaces are "trouble waiting to happen" no matter where they are!**

## Ground Isolators for Data Interfaces



### RS-232 Isolator

see [www.bb-elec.com](http://www.bb-elec.com)  
also, for similar products  
see [www.telebyteusa.com](http://www.telebyteusa.com)



### USB 2.0 Isolator

see [www.electronics-shop.dk](http://www.electronics-shop.dk)

**Jensen is currently exploring the feasibility of an HDMI isolator ...**

## Recap: AC Power & Unbalanced Interfaces

- Safety grounding must **NEVER** be compromised!
- Earth ground has essentially nothing to do with noise
- There are always voltage differences between “grounds”
- Magnetic coupling in premises power wiring is the major source of these voltage differences
- Unbalanced interfaces are a potential noise disaster!
- Noise in unbalanced interfaces is not about shielding
- “Ground loops” are always created when signal cables interconnect AC-powered equipment
- Ground isolators cure the “unbalanced” problem

## POWER-LINE ISSUES and TREATMENTS

"Today's residential systems contractors face unprecedented challenges where high resolution, trouble-free operation is required. From inducing AC **ground loops**, **video hum bars**, static bursts, damage from AC line surges and variable audio and video performance, comprehensive control and conditioning of AC power is no longer an option."

**Similar assertions are made by so many, so often that most customers accept them as truth. This "power-line paranoia" exploits the seductively-appealing notion that "dirty power" is to blame for all system noise problems!**

"Power Conditioning" has been a high-growth, and high-profit, business for nearly 20 years. **Most of the claims made for such "conditioning" are never substantiated in any meaningful or scientific way.** Many of the claimed benefits, as well as carefully contrived demonstrations, truly test the limits of credibility in an engineering sense ... "deeper colors" ... "better soundstage imaging" ... **WHAT?**

## “Mesh” vs “Star” Controversy

- **“Mesh”** grounding
  - Attempts to create a uniform potential over large areas using a network of ground wires that, to some degree, approximates a solid ground plane at high frequencies. Ground loops exist but are ignored.
  - **Long advocated by the IT community** since 60 Hz is “out of band” for most data and signal-to-noise requirements are very low. As clock frequencies have risen, this method has gradually fallen out of favor.
- **“Star”** (single-point) grounding
  - Prevents coupling of noise by avoiding shared conductors wherever possible
  - **Long advocated by the analog community** since 60 Hz is “in band” for audio and video and signal-to-noise must be very high. This method routes noisy currents in conductors separate from sensitive ones. Various circuit returns are joined at a single point.

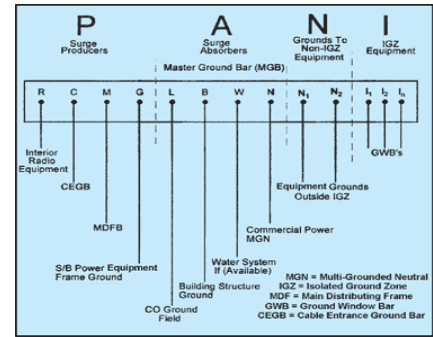

Bill Whitlock, 9/4/2012

Overview of Audio System Grounding & Interfacing

189

The IT community generally persists in claiming that everyone should ground systems the way they do – failing to appreciate the reasons for “star” grounding in audio equipment. The PANI system was developed by telephone companies primarily to deal with lightning and fault currents arriving at switching stations via subscriber lines. The PANI system should NEVER be used as a substitute for the premises wiring safety ground system. NEC requires that the safety ground conductor be inside the same conduit as the line and neutral conductors ... always!

## Buildings with Metallic Conduit

Normal saddle-grounded or "SG" outlets connect safety ground to conduit when the J-box is installed.

"SG" Outlet



$V_{DIFF}$  is magnetically induced into safety ground wires as current flows in other wires in the conduit.  $V_{DIFF}$  is what drives ground loop currents through signal cables.

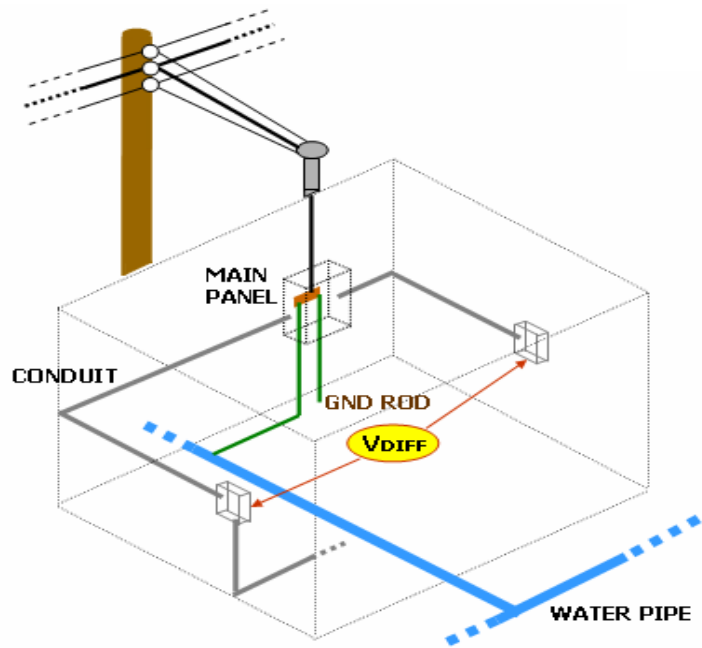

**A good way to effectively eliminate this induced voltage is tight twisting of each L-N conductor pair in the conduit.**

## “Technical” or “Isolated” Grounding

- **Conduit touching ANY separately-grounded metal causes new noise currents in safety ground system**
- Isolated-ground outlets do **not** connect safety ground to their mounting saddle but only to the **green wire**
- IG outlets reduce extraneous, and often intermittent, ground noise problems
- Covered by NEC Article 250-74
- Does not apply to premises wired with Romex® and/or plastic J-boxes
  - It's already an isolated ground system!

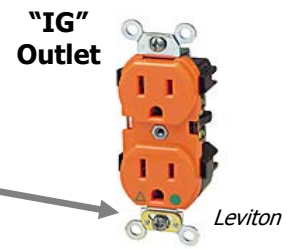

Bill Whitlock, 9/4/2012

Overview of Audio System Grounding & Interfacing

191

**It remains controversial, especially among electrical contractors, but even among audio experts. I believe there are many situations where it can be of great benefit – which ones depends on many factors.**

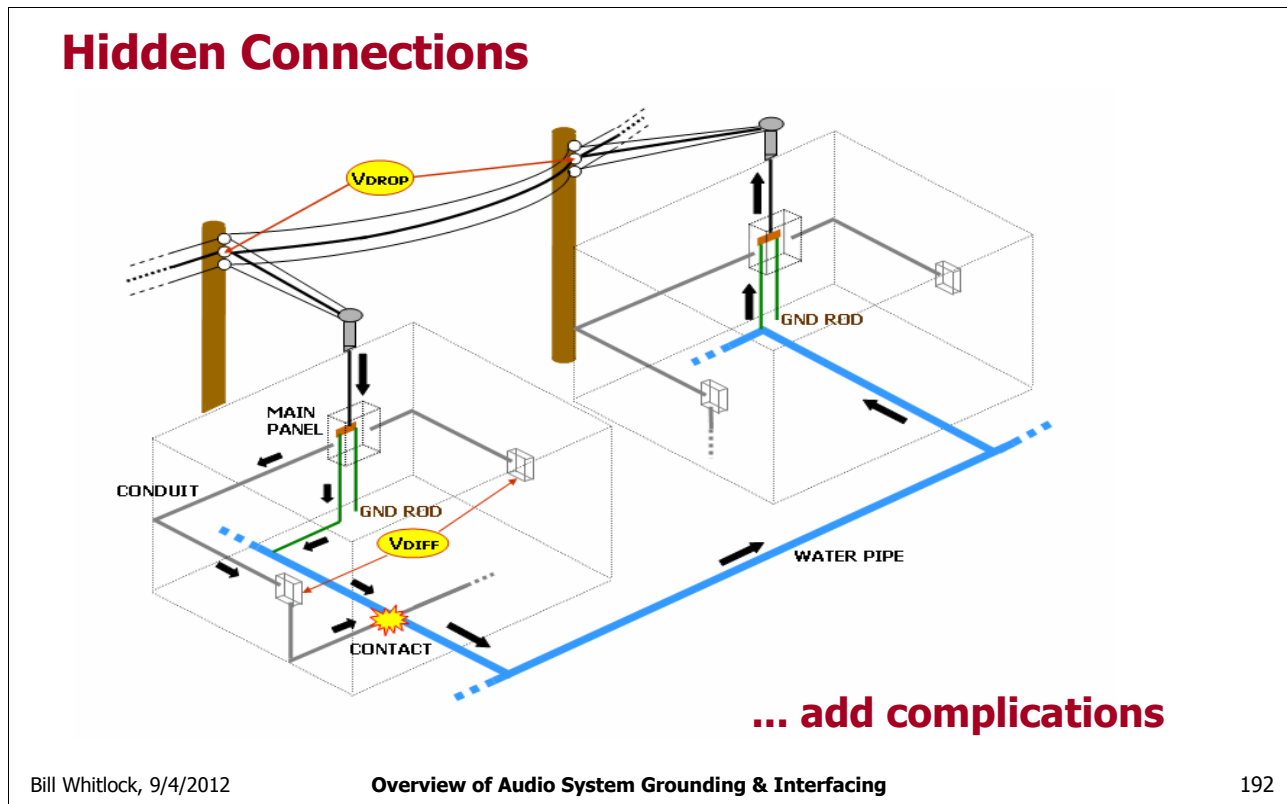

**If conduit is part of the safety ground system, these contacts allow other power-line currents to flow in them – with resulting voltage differences. THIS IS WHY ISOLATED GROUNDING IS POPULAR IN LARGE COMMERCIAL BUILDINGS WHERE UNINTENDED, AND OFTEN INTERMITTENT, CONTACTS EXIST BETWEEN CONDUIT AND OTHER GROUNDED STRUCTURES. Contact with building steel, HVAC structures, gas pipes, etc. can cause intermittent problems.**



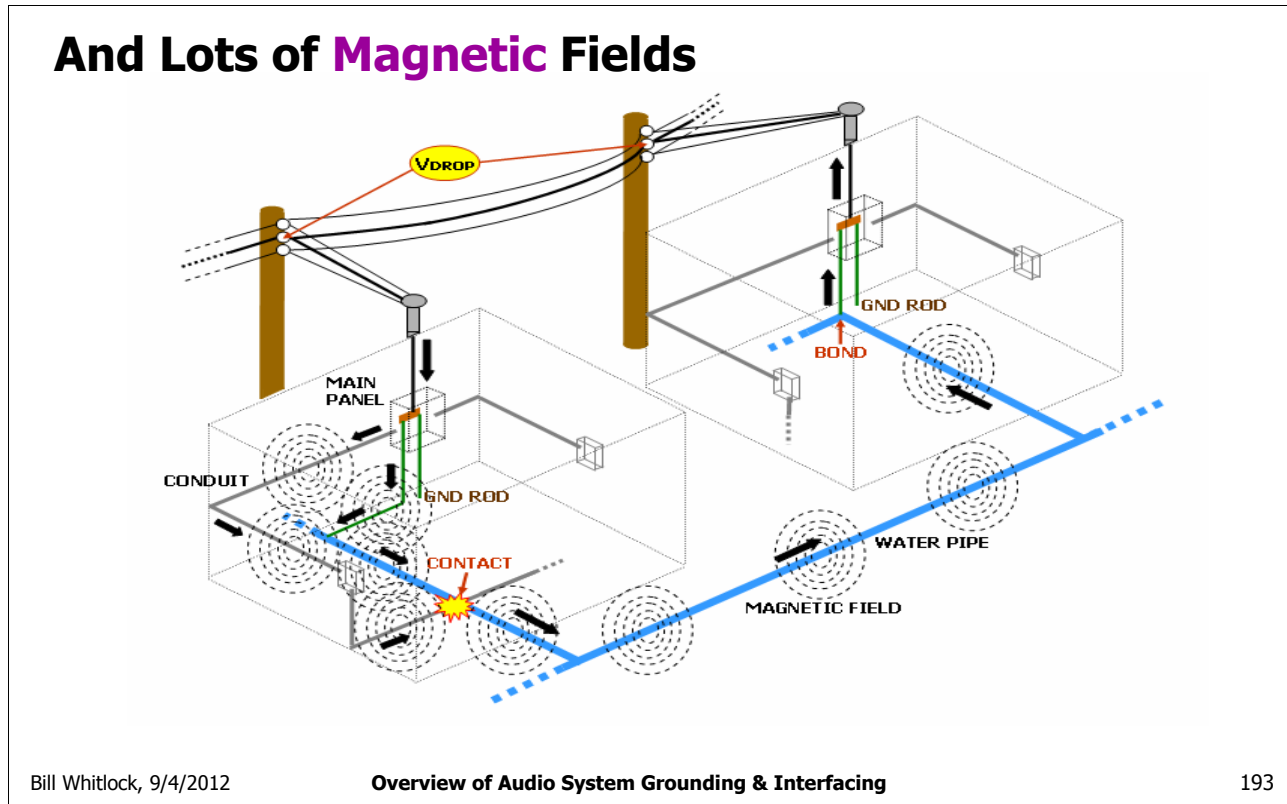

Magnetic fields can induce voltages in nearby cables. **They can also cause serious hum in electric guitars in the vicinity!** Note that VDROP is created as high current (100 A or more) flows in the resistance of the neutral wire connecting the two utility poles. When neutral is tied to plumbing (as NEC requires) in each building, another route for current flow is created through the plumbing in each building and the water pipe in the street. In a consulting job, I found 13 A flowing in a water pipe under the stage in a rehearsal hall. Their complaint was that no one could play an electric guitar (very sensitive magnetic field detector) on that end of the stage. Is it any wonder? The current was generating a magnetic field with a strength of about 70 mG at waist level on that end of the stage. During a trip to the basement, my clamp-on ammeter measured the 13 A in the pipe. The cure was to install an insulated coupler in the water line right at the building side of the meter. That kept the premises plumbing properly grounded while stopping the current flow into the street!

## Recommended Instruments



Ideal SureTest®  
Circuit Analyzer  
Model 164  
(about \$230)



AEMC  
Clamp-On Multimeter  
Model 565  
(about \$270)



AlphaLab TriField®  
EMF Meter  
[www.trifield.com](http://www.trifield.com)  
(about \$170)

Bill Whitlock, 9/4/2012

Overview of Audio System Grounding & Interfacing

194

The Sure-Test analyzer can measure line voltage, test for full-load voltage drop (on either 15A or 20A rated branch circuits), test for ground resistance, and discover dangerous outlet wiring errors. The Tri-Field meter will indicate AC magnetic fields (with 3 milli-gauss and 100 milli-gauss full-scale ranges), AC electric fields, and has a broadband RF detector as well (suitable for testing leakage for microwave ovens or finding hidden “bug” transmitters). Being able to measure low-level magnetic fields can be especially handy in cases where the complaint is that “my electric guitar hums” – which is very often due to ambient magnetic fields.

## “Power Conditioning” Can Include

- **Short-term over-voltage protection** (mostly MOV-based)
  - “Transients” and “spikes”
- **Long-term over/under-voltage protection** (voltage regulation)
  - “Swells” and “surges”
  - “Sags” and “brown-outs”
- **Isolation transformers** (control “common-mode” noise)
- **“Balanced” power** (control leakage current noise)
- **Filters** (control high-frequency noise)
- **Other “bizarre” stuff** (presumably to invoke magic)
  - “Tice clock”
  - Exotic cords, plugs, outlets, and wire

It’s dangerous to generalize, but some of these functions are “band-aids” for poorly-designed equipment and some are legitimate concerns.

## Facts to Keep in Mind ...

- Ground voltage differences are **the** driving force behind nearly all audio and video noise problems
  - **They are generated by magnetic induction in the premises wiring itself, the "conduit transformer"**
  - **They approach zero between system devices powered from closely-spaced AC outlets**
- **Many benefits attributed to "power conditioning" are actually due to the tight cluster of output outlets!**
- **The coupling mechanism in signal cables that causes hum and buzz ceases to operate beyond about 30 kHz**
- **Power-line "common-mode" (neutral to ground) noise is, by definition, zero at the N-G bond**

Common-mode noise can only be generated within a premises, between the N-G bond and the load in question. **For system noise reduction, a simple outlet strip often works as well as, or even better, than a "power conditioner."** Filtering in most power conditioners only begins to work at frequencies above 30 kHz – at that and higher frequencies, noise no longer couples in cables like it does at lower (audio) frequencies.

## Power Isolation Transformers

- Ground loops unaffected since input and output grounds are tied
  - Applies to all cord-connected filters and isolation transformers
    - UL 1950 and IEC 950 prohibit "isolation" of safety ground
  - Electrostatic/Faraday shielding can add noise current to safety ground
  - Touted high-frequency noise reduction specs are unrealistic
    - Measurements made in lab on low-Z **ground plane**
    - Real-world grounding is via high-Z **wires** or conduit
- Only a permanently-installed, hard-wired transformer, configured as a "**separately-derived system**" per Code, can establish a new N-G bond, which has many noise-reducing benefits
  - See Middle Atlantic Products white paper (see Recommended Reading at end)

See [www.middleatlantic.com](http://www.middleatlantic.com) to download the white paper.

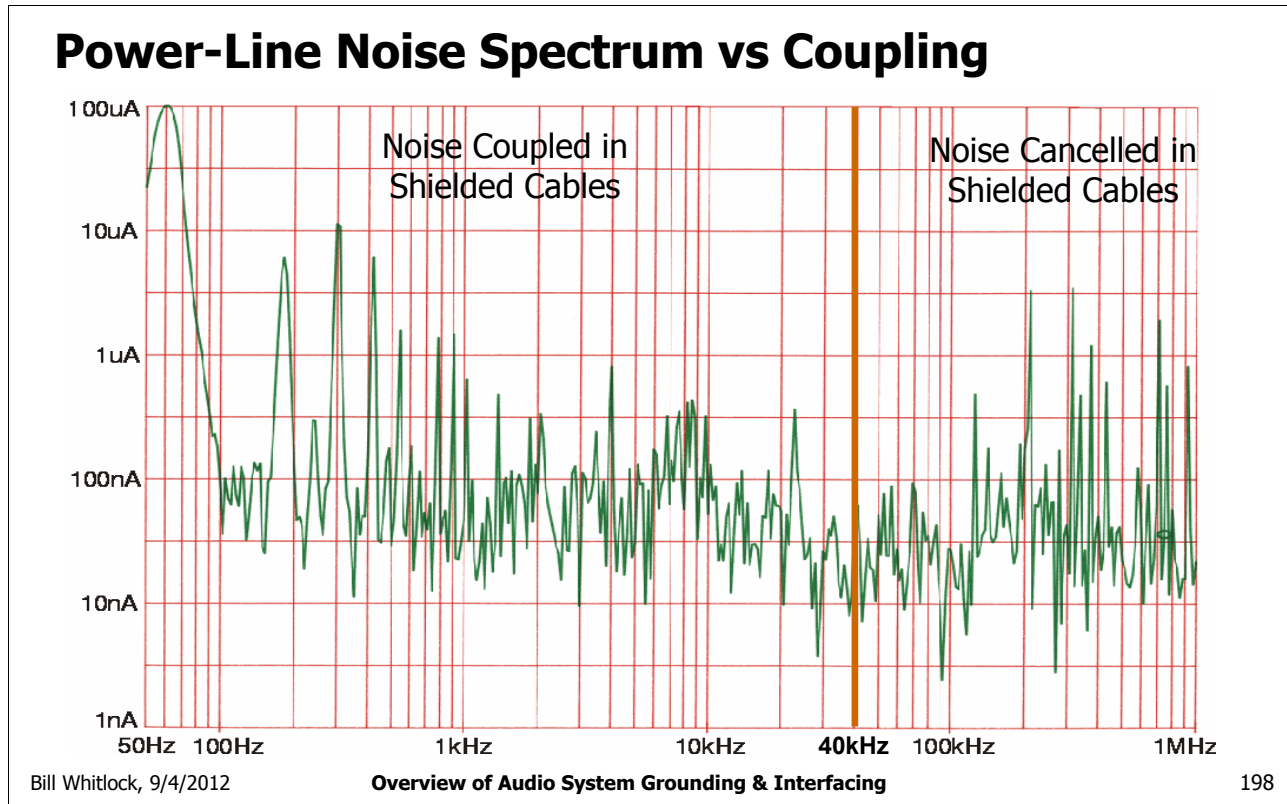

This plot is an actual spectrum analysis of leakage current in a 3 nF capacitance connected to an AC outlet at former Jensen headquarters in Van Nuys, California. It represents a more-or-less typical common-mode + normal mode noise spectrum. The graph is split into sections below and above about 40 kHz. Below 40 kHz, magnetic coupling in shielded cables is minimal so that a) common-impedance coupling occurs in unbalanced interconnect cables, and b) end-to-end voltage difference is presented to the line receiver as common-mode voltage in balanced interfaces. Above 40 kHz, magnetic coupling in shielded cables is maximum, allowing the end-to-end voltage difference to be fully coupled to the cable's inner conductor(s), which subtracts it from the signal(s) seen at the receiver, resulting in zero noise coupling in unbalanced interfaces and zero common-mode voltage in balanced interfaces. **It should be clear that any power-line filter that only begins to attenuate at 40 kHz is a case of "too little, too late."**

## Power-Line Filters Useless at Audio Frequencies!

- Virtually all AC power-line filters, whether very simple or complex, have **trivial attenuation below 30~50 kHz**
- Shielded cables (balanced or unbalanced) nullify the effects of shield current above 10~30 kHz
- A power-line filter that might help would be as big as a refrigerator
  - Serious attenuation would need to begin at a few hundred Hz, not tens of thousands!
- **Filters are most effective when located at the noise source**

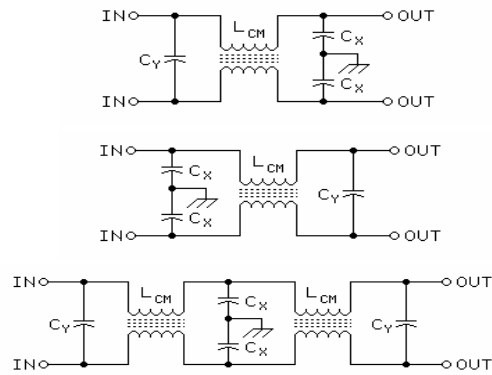

## Power Isolation Transformer

Cord-connected "point of use" type shown

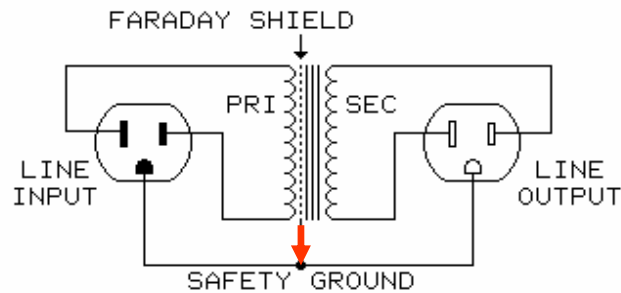

**Safety ground can't legally be interrupted, so ground loops will remain.**

The Faraday shield (also mistakenly called an "electrostatic shield") prevents capacitive coupling of high-frequency noise to the output but it couples the noise into the local safety ground system. This explains reports that such transformers often make noise problems worse.

**Plug-and-Cord connected isolation transformers are generally of very little benefit.** Further, they cannot legally disconnect safety ground.



## So-Called “Balanced Power”

- Properly called **SYMMETRICAL** power
  - Has very seductive intuitive appeal
  - **NOT** similar to balanced audio lines in any way!
  - Uses transformer having 120 V center-tapped secondary
    - **Both line and neutral output blades are energized at 60 V**
  - Although advertising often implies endorsement, NEC seriously **restricts** its use – because it’s potentially dangerous!
    - **ONLY FOR PROFESSIONAL USE**
    - **NOT** to be used with lighting equipment, especially screw-base bulbs
    - **MUST** have GFCI at outputs
- Only technical function is to reduce leakage currents
  - **Leakage currents are trivial** system noise sources
  - **Reported noise reduction generally less than 10 dB**
  - **Any real benefit likely due to its clustered outlets**

**This is an example of “marketing gone wild” if ever there was one!**

## Symmetrical AC Power

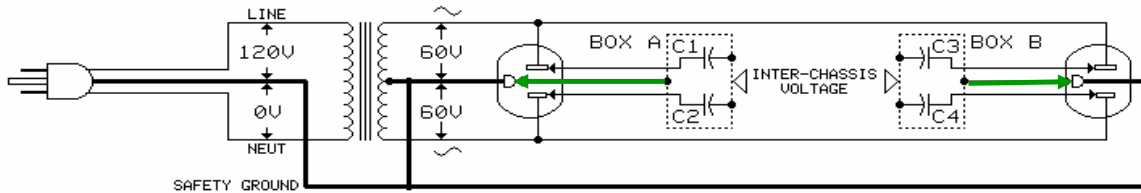

Total leakage current to safety ground could be cancelled IF parasitic capacitance pairs, shown as C1/C2 and C3/C4, were precision matched. This is **not** likely to ever happen!

The theory is pretty simple: if symmetrical (equal but opposite instantaneous polarity) AC voltages are applied to equal-valued capacitors, say C1 and C2 above, the two current flows would also be equal but opposite and cancel each other ... no net current into safety ground. **But leakage currents flowing in safety ground wiring are not a significant source of ground voltage differences ... as so many apparently believe.**

## The "Ground Lift" Feature



### Legally Disconnects Safety Ground ... BUT

Bill Whitlock, 9/4/2012

Overview of Audio System Grounding & Interfacing

203

**Because this unit has the required GFCI on its output outlets, it is legally allowed to interrupt safety ground. Paradoxically, the same can't be done when a premises AC outlet is replaced with a GFCI type. NEC says that, if a safety ground is available to the outlet, it MUST be connected ... even if the outlet is a GFCI protected one. Although this unit claims to eliminate ground loops via the "LIFT" switch, there's a catch ...**

### "Nuisance Trips" May Occur

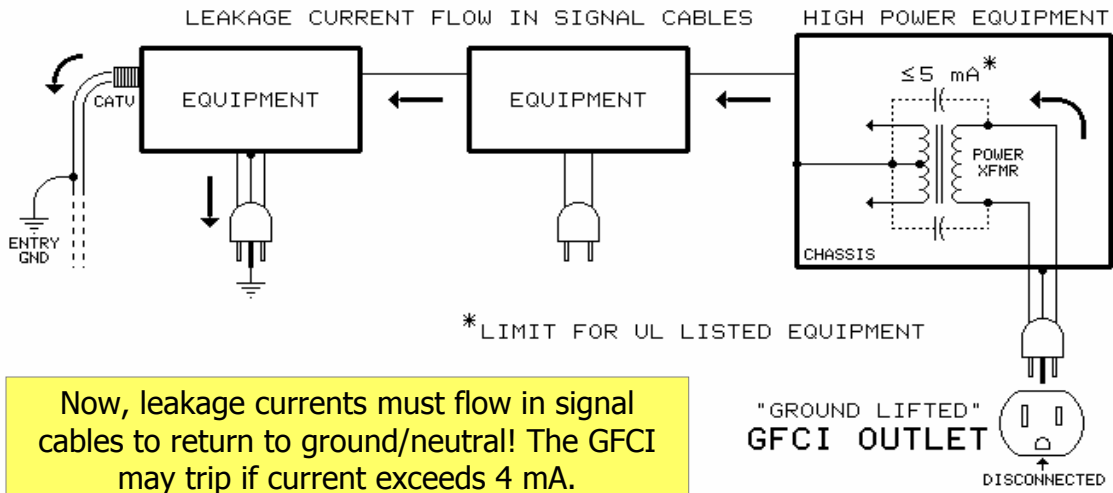

**This is especially likely if several devices are plugged into the "lifted" outlets ... individual leakage currents accumulate!**

## GFCI for Safety

- Ground-fault circuit interrupter or GFCI does **not** require a ground connection to function properly
- Senses difference between line and neutral currents
  - **Current NOT returning on neutral is presumed to be flowing through a person**
  - **Required to trip between 4 and 7 mA**
- NEC allows upgrade of 2-prong AC outlets (in pre-1960 homes) with GFCI outlets
  - **Ground must be connected if available**
  - If no ground is available, outlet must be marked "No Equipment Ground" and may be used without grounding



**Often these GFCI units are the best solution for an older home with 2-prong outlets.**

## Noise IS Sometimes the Electrician's Fault

- In new construction, some AV contractors claim that up to 25% of AC outlets are mis-wired.
  - Neutral-Ground swaps at outlets are common but **cannot be detected** by ordinary low-cost outlet testers.
- Multiple Neutral-Ground bonds is also common when sub-panels are part of premises power distribution
  - NEC allows **only one** and it must be at the **main disconnect panel**
  - Many boxes arrive with the N-G jumper in place but it must be removed if the box is used as a sub-panel
- Both cause extraordinarily large voltage drops in the safety ground wiring
  - Load current, up to 20 A, normally flows in Neutral wires
  - Leakage current, up to perhaps 0.1 A, normally flows in Ground wires

NEC allows a 5% voltage drop at an outlet under full load. This says that the voltage at a 120 V outlet under full-rated load could drop by 6 V to 114 V. This drop will, of course, be highest at the outlet farthest from the panel. Since wire gauge must be the same for L and N, it means that 3 V will be dropped on each (which makes the wires warm – that's 60 watts of heat for each on a 20 A circuit). But if the current returns on safety ground rather than neutral, we have up to 3 V of voltage difference in the safety ground system. This is some 100 times higher than voltage differences in a properly-wired system. But, because everything except your AV system works as it should, electricians often dismiss us by saying "It's not my problem. Look – everything works!"

## The N-G Swap, a Real Problem



**THIS  
WON'T  
FIND IT**

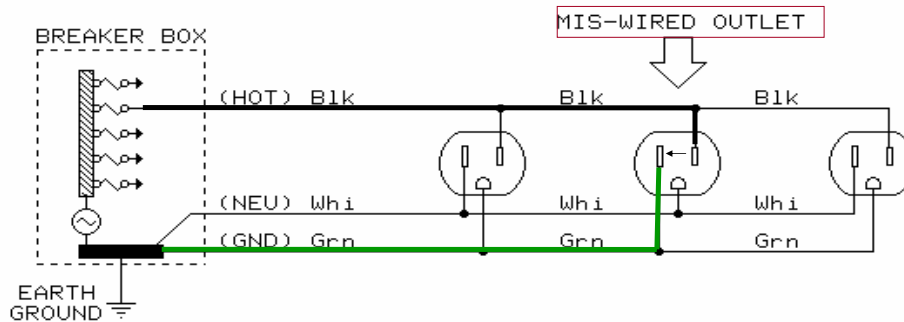

**Load current** now flows in **safety ground** wiring. Its voltage drop, up to 3 volts, appears as a ground difference voltage to the system – creating truly **severe** noise problems! **The swap is not detectable with any outlet tester, but a clamp-on ammeter can easily find it!**

This wiring error is normally not a safety hazard but definitely a big headache regarding system noise. The simple outlet tester can't find a N-G swap because both N and G are grounded at the breaker box. The simple tester can only verify that there's 120 V between the hot blade and the other two. If the other two are reversed, it has no way to know! Again, it's all about where the current is flowing – and it should NOT be in the safety ground!! **In general, any current over 100 mA in a safety ground wire indicates a problem.**

## Another: Multiple or “Bootleg” N-G Bonds

- **NEC prohibits more than one N-G bond**
  - Must be at “main disconnect” power panel
  - Others allowed ONLY at “separately-derived system” transformers
- Extra bonds most often found at sub-panels
  - New sub-panels often arrive with N-G bond jumper in place
  - **Electrician forgets to remove jumper when panel is installed**
- Accidental connections
  - Neutral wire pinched and shorted to metallic J-box
  - Staple shorts N to G in Romex
  - Electric dryers (240 V) in old homes may tie N to plumbing
- **Testing should be done **only** by a qualified electrician!**

There are various methods for finding “stray” N-G bonds. An ohmmeter is rarely useful. **Because most methods involve disconnecting the legal N-G bond and then re-energizing circuits to trace the errant current flow, the procedure is potentially dangerous and should be done only by (or under the direct supervision of) an experienced, qualified professional. NEVER WORK ALONE AND KEEP ONE HAND IN YOUR BACK POCKET!**



## IS IT SAFE?

- It's **NOT UL Listed!**
- This device claims to eliminate ground loop problems
- Uses a pair of back-to-back rectifier diodes in series with safety ground connection
- Essentially an open circuit until ground voltage difference reaches about  $\pm 0.6 \text{ V}$  ( $\sim 400 \text{ mV rms}$ )
- But will it survive a 100 A fault for 2.5 seconds or a 1,000 A fault for 10 ms\* without opening up?



The current and time numbers noted \* were taken from a survey by Underwriters Laboratory of 1,000 homes and represent a realistic range of short-circuit current and time taken for the circuit breaker to trip open (it depends mostly on the distance between tested outlet and breaker panel). I've done a "teardown" (de-potting) of this product. Based on what I saw (and know about the failure mechanisms of semiconductors), I would not depend on this device to protect my life during an equipment fault scenario. **These are serious questions!**

## About Surge Suppression

- Paranoia and pseudo-science make it easy to sell surge protection devices of all kinds
- Mindless use of **conventional** suppressors can actually **increase** risk of equipment damage!
- By far, the most widely-used suppressors employ three **MOV** (metal-oxide varistor) devices that **divert** (shunt) surge current into the **safety ground** system
- When surges occur, they create brief but **extreme** voltage differences in the **safety ground** system!
- **Equipment interfaces are often damaged ...**

**A case of marketing that involves selling “protection”. Do you know what a Joule is?**

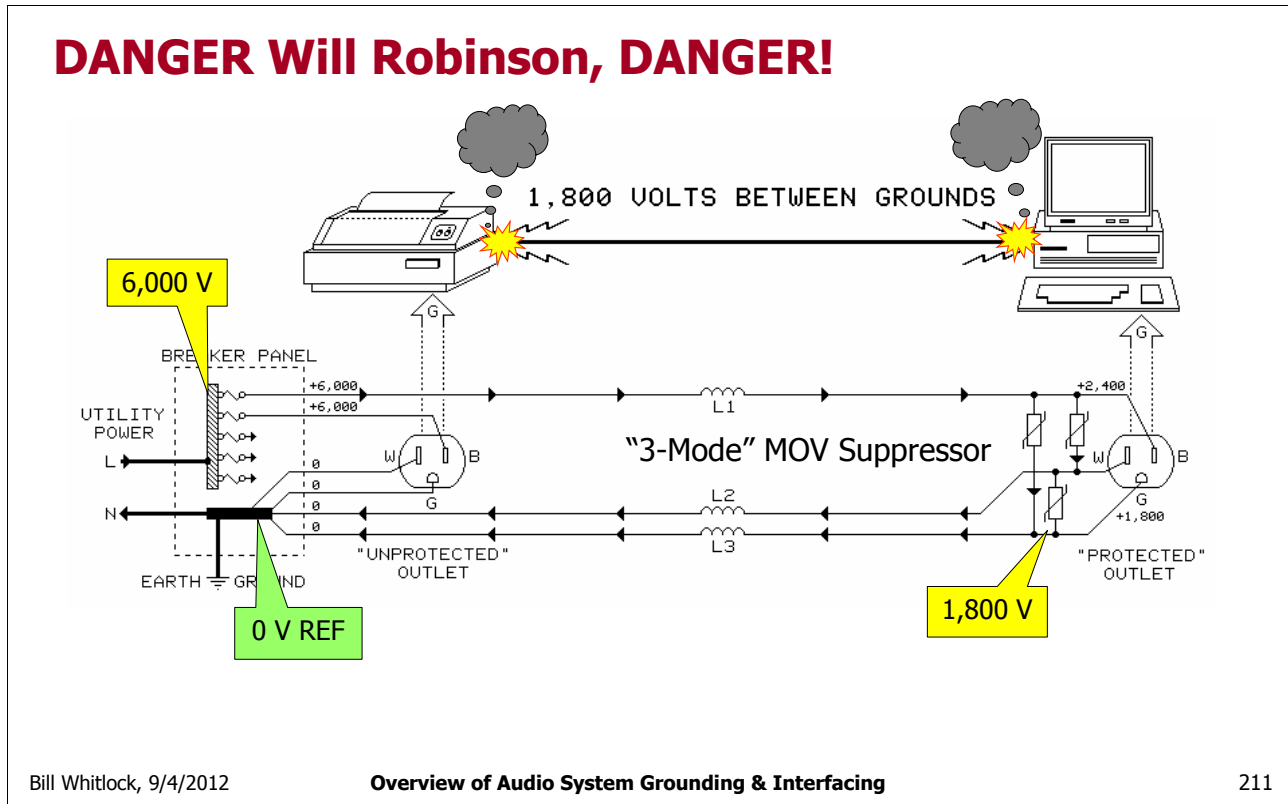

Upwards of 2,000 volts across **any** signal interface is very likely to **release the factory-installed smoke!**

## Think Different ...

- Protect from the biggest threat, lightning-induced surges, with a “whole house” device at main power entry panel – MOV is OK there
- Whether on a branch-circuit or in the equipment rack, I recommend only **series-mode** suppressors
  - They present a **high impedance** (inductor) to block the surge energy
  - **They DON'T dump surge currents into safety ground**



*SurgeX*

Bill Whitlock, 9/4/2012

Overview of Audio System Grounding & Interfacing

212

Surge-X is one of several makers of series-mode surge suppressors. I have no financial ties to the company, I just like the product.

## Thanks for Your Attention!

Have a question? Want a copy of this presentation? See me at CEDIA Booth **3052** or send me an e-mail: [whitlock@jensen-transformers.com](mailto:whitlock@jensen-transformers.com)

*Handbook for Sound Engineers, 4<sup>th</sup> edition,* has three chapters written by Bill Whitlock

**jensen**  
ISO-MAX®

**Jensen Transformers, Inc.**

9304 Deering Avenue

Chatsworth, California 91311

[www.jensen-transformers.com](http://www.jensen-transformers.com)

Tel: (818) 374-5857 - Fax: (818) 374-5856

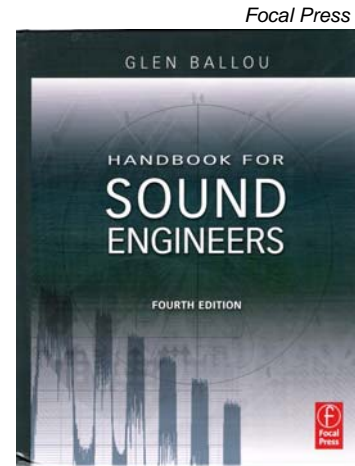

Bill Whitlock, 9/4/2012

Overview of Audio System Grounding & Interfacing

213

Jensen Transformers, Inc., 9304 Deering Avenue, Chatsworth, CA 91311

Phone: (818) 374-5857 - Internet: [www.jensen-transformers.com](http://www.jensen-transformers.com) - E-mail: [info@jensen-transformers.com](mailto:info@jensen-transformers.com)

Open 9 AM to 5 PM, Monday thru Thursday, closed Fridays, visitors by appointment only.

All content Copyright 2012, William E. Whitlock

## Suggested Reading

1. **Integrating Electronic Equipment and Power into Rack Enclosures**, Middle-Atlantic Products, at <http://www.middleatlantic.com/pdf/PowerPaper.pdf> and its addendum at <http://www.middleatlantic.com/pdf/Power%20Paper%20Addendum.pdf>. This document was a collaborative effort of the MAP staff and several industry experts, including Neil Muncy and myself.

Following Papers at [http://www.apc.com/prod\\_docs/results.cfm?DocType=White%20Paper&Query\\_Type=10](http://www.apc.com/prod_docs/results.cfm?DocType=White%20Paper&Query_Type=10)

2. **White Paper #8, Inter-System Ground Noise: Causes and Effects, Rev 2**, APC, Neil Rasmussen
3. **White Paper #9, Common-Mode Susceptibility of Computers, Rev 1**, APC, Neil Rasmussen
4. **White Paper #21, Neutral Wire Facts and Mythology, Rev 1**, APC, James Spitaels

Following Papers at [http://www.jensen-transformers.com/apps\\_wp.html](http://www.jensen-transformers.com/apps_wp.html)

5. **Audio Transformers**, by Bill Whitlock, from *Handbook for Sound Engineers, Third Edition*, Glen Ballou, Editor

For a good, yet entertaining introduction to electricity, check out **The Manga Guide to Electricity** by Kazuhiro Fujitaki

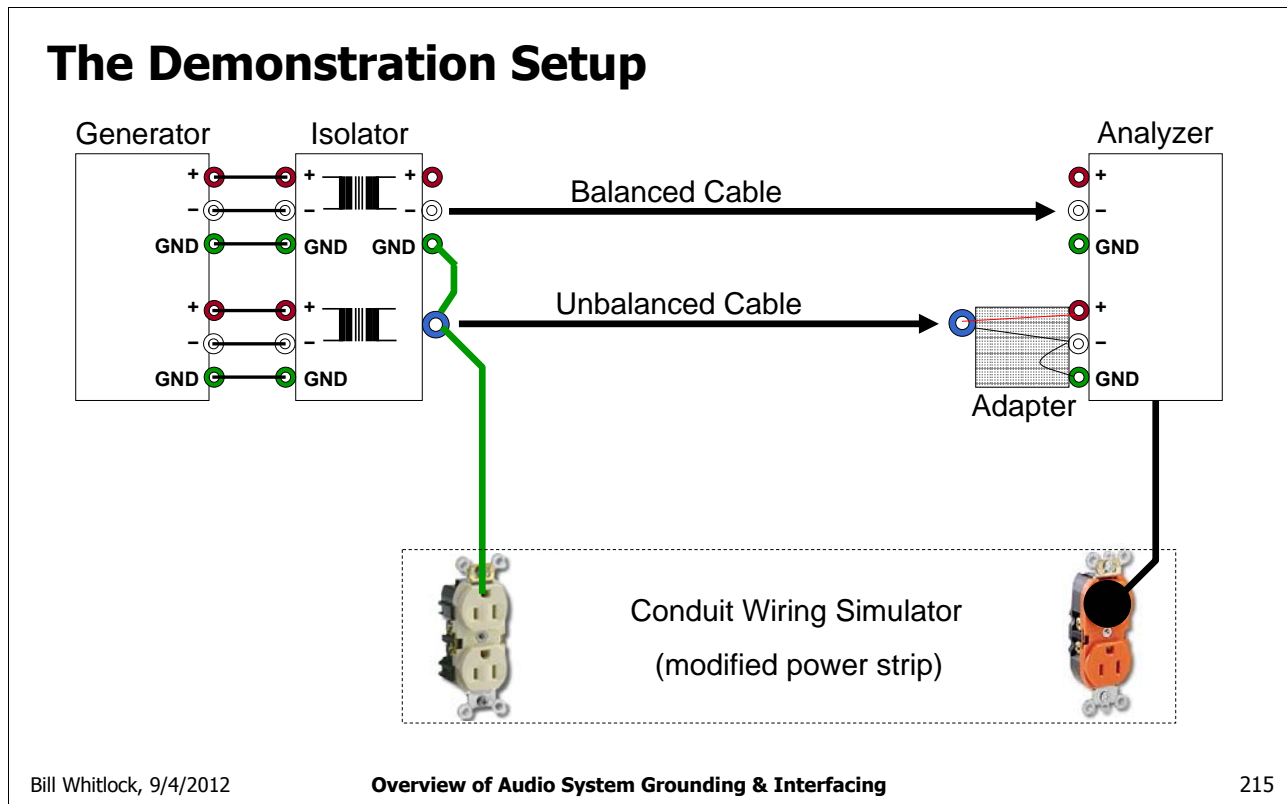

Since the Audio Precision instrument has a common-ground for its generator and analyzer. Therefore, the “isolator” above allows the generator outputs to reference a different ground potential (the green wire). This re-creates a real-world scenario where the signal source device and destination device are physically separated and have a small ground voltage difference between them.

The “Conduit Wiring Simulator” inserts the primary of a transformer between the neutral connections of the two outlets. The transformer’s secondary is inserted between the ground connections of the two outlets. Any current drawn by loads on the orange outlet flows through the transformer primary and magnetically induces a ground voltage difference between the outlet ground connections. This is exactly what happens in normal commercial premises wiring. It simulates a conduit run about 15 feet long (each winding of the transformer has an inductance of about 7 uH) where wire positioning is worst case. For more details on the “conduit transformer”, see “Ground Loops: The Rest of the Story” by Bill Whitlock and Jamie Fox, presented at the 129<sup>th</sup> AES Convention, Nov 4-7, 2010.